

Liaison and Coordination Committee
on Central Bank Digital Currency

Interim Report

July 5, 2022

(English translation prepared by the Bank of Japan staff based on the Japanese original)

Contents

Introduction.....	1
1. Basic functions and core features of a CBDC	2
1.1 Basic functions of a CBDC.....	2
1.2 Core features required for CBDC	4
1.3 CBDC issuance and distribution.....	5
2. CBDC experiments.....	11
2.1 Proof of Concept Phase 1.....	11
2.2 Proof of Concept Phase 2.....	20
2.3 Next steps.....	22
3. Investigation of institutional arrangements	24
3.1 Entities constituting the CBDC system and their roles: vertical coexistence	24
3.2 Relationship with other types of payment instruments: horizontal coexistence	32
3.3 Ensuring privacy and proper handling of user information.....	36
3.4 Relationship with cross-border payments.....	37
3.5 Next Steps	39
Concluding thoughts and next steps.....	41
Appendix: Status of works abroad.....	43

Introduction

Central Bank Digital Currency (CBDC) is a new form of digital money issued by a central bank.

In October 2020, the Bank of Japan (BOJ) publicly announced its approach to a general purpose CBDC intended for use by a wide range of entities, including individuals¹. As mentioned then, “While the Bank of Japan currently has no plans to issue CBDC, from the viewpoint of ensuring the stability and efficiency of the overall payment and settlement systems, the Bank considers it important to prepare thoroughly to respond to changes in circumstances in an appropriate manner.”

In line with the Approach, in April 2021, the BOJ started experiments relating to CBDC. “Proof of Concept (PoC) Phase 1” aimed at evaluating the basic functions of a CBDC was completed in March 2022, followed in April by a transition to “Phase 2,” which investigates the feasibility of more complex additional functions. Also, in parallel, the BOJ has been investigating institutional arrangements, such as methods for ensuring financial stability and how a central bank should coordinate with the private sector.

Throughout the experiments, the BOJ recognizes the importance of staying in close contact with stakeholders in and abroad and leveraging a wide range of perspectives for further investigation. Toward that end, the Liaison and Coordination Committee on Central Bank Digital Currency (“Liaison Committee” hereinafter) was established in March 2021, with members coming from the private sector, the government, and the BOJ (Refer to Attachment for the member of the Liaison Committee), to share information on the progress of the PoC and to consult on future plans.

Summaries of the Liaison Committee’s discussions are posted on the BOJ’s website (available only in Japanese), and as experiments and investigations into institutional arrangements get fleshed out further, it becomes increasingly important to accurately communicate to a wide range of stakeholders and work closely with them to exchange ideas. With that in mind, the BOJ’s Payment and Settlement Systems Department, which is the secretariat of the Liaison Committee, considers to publish this interim report so as to communicate the materials and discussions of the Liaison Committee in a comprehensive manner.

The BOJ or the Liaison Committee alone never intends to design the development of a payment

¹ See “The Bank of Japan’s Approach to Central Bank Digital Currency,” 9 Oct 2020. Referred to as “the Approach” in this paper.

system. The decision as to whether or not a CBDC should be issued will have to be a judgement by the Japanese people. We expect that this paper will serve as a foundation for further discussion among a wide range of stakeholders on whether to introduce a CBDC and what framework it should take.

1. Basic functions and core features of a CBDC

1.1 Basic functions of a CBDC

As mentioned above, CBDC is a new form of central bank electronic money². Today, central banks issue money in the form of cash (banknotes). CBDC would be different from cash in that it is issued in digital format. Also, although central banks do issue electronic money to banks and other institutions in the form of central bank deposits (in the BOJ’s case, these are “current account deposits at the BOJ”); CBDC would be different from this as well, in that it is a new form of electronic money unlike what exists now.

CBDC would be issued as central bank liabilities and would be held as assets by entities other than the central bank. CBDC is transferred between individuals and firms in exchange for goods and services, thereby functioning as a payment instrument. Also, by CBDC being issued denominated in their home countries’ fiat currency, it would function as a unit of account in a nation’s economy.

Figure 1: Types of money

		Form Digital ● Physical ○	Issuer Central bank ● Others ○	Balance JPY trillions (end Dec 2021)
Wholesale	Central bank deposits	●	●	543
	Wholesale CBDC	●	●	—
Universal	Bank deposits	●	○	1,630
	Cash	○	●	127
	General purpose CBDC	●	●	—

Note: Bank-deposit balances are the total of transferable deposits, time and savings deposits, and certificates of deposits at domestically licensed banks, foreign banks in Japan, financial institutions for agriculture, forestry and fisheries, and financial institutions for small businesses.

Source: BOJ

² The Bank for International Settlements (BIS) defines a CBDC as “a digital form of central bank money that is different from balances in traditional reserve or settlement accounts.”

Money can be classified as “wholesale money” used by a limited number of entities, mostly financial institutions, for large transactions, or as “general purpose money” available for a wide range of entities including individuals and firms. Same classification is applicable to CBDC, and the BOJ currently explores general purpose one. The Liaison Committee’s discussions and this paper are focused mainly on “general purpose CBDC.”

Compared with bank deposits, which are one of general purpose money issued by private payment service providers (PSPs; e.g., banks and non-bank PSPs), CBDC, being issued directly by the central bank, will have concomitantly greater safety, and will impart finality to settlements. Also, as a public payment instrument, it incorporates neutrality and inclusiveness. In terms of its relationship to cash (banknotes), it is still central bank money, but CBDC has lower costs associated with transport, use, and storage. Unlike cash, the use of digital technology makes it possible to provide an array of additional functions and services to users. Taking these features into consideration, the Approach promotes the idea that CBDC in Japan should function as “a foundational payment instrument alongside cash,” and points out the possibility that CBDC leads to “developing payment and settlement systems suitable for a digital society” as viewed from a wider range of perspectives.

Thus, many ways of utilizing CBDC can be conceivable. Still, that does not necessarily mean that CBDC should inherently be equipped with all convenient functions. In reality, even today, the fact that cash has “certain inconveniences” due to its being tangible (it is bulky and prone to theft) allows coexistence with deposits and other payment services, and strikes a right balance between convenience and stability in the payment and settlement system as a whole. In contemplating the introduction of CBDC, we need to consider so as not to interfere with the central bank’s policy goals of price stability and financial stability. Taking these points into account, there might need to be a way to apply certain quantitative limits on CBDC holdings and/or transactions, and there needs to be a thorough investigation into how CBDC would work with private money and the division of roles with them. On that point, an opinion that “considering the potential effects that CBDC might bring, it might be appropriate to assign certain limits on the functions and features of CBDC at its initial rollout, and tweak these constraints gradually.” was raised at the Liaison Committee.

For its own part, the BOJ is giving consideration to these points, and is proceeding with investigations into the features of CBDC and its institutional arrangements, from the perspective of ensuring the overall stability and efficiency of the payment and settlement system.

1.2 Core features required for CBDC

As a general purpose money issued by a central bank, CBDC must incorporate the following core features.

First, a point of discussion is how to ensure universal access—that CBDC is available to anyone as a foundational payment instrument. The typical scenario for CBDC usage would be, like private digital money, to operate that with a dedicated application on smartphones. For those users who would have some difficulty to use that, a topic for study is card devices. Retailers would have payment terminals to settle transactions with customers. In any case, there would need to be considerations in designs that provide convenience and portability in these endpoint devices.

Second, for secure CBDC payments, sufficient security need to be ensured. If CBDC were to be issued, out of the need to protect user and transaction data appropriately, as well as risk of attacks aiming at counterfeiting or unauthorized use of CBDC, there would need to be appropriate measures in terms of technology and system operations regarding cybersecurity and information security. On this point, an opinion that “the security issues are not just matters of the BOJ’s system. It is important that intermediaries address them as well.” was raised at the Liaison Committee. Additionally, due consideration must be given to anti-money laundering and combating the financing of terrorism (AML/CFT).

Third, CBDC system must incorporate resilience so that it can be used anytime, anywhere. Specifically, there need to be efforts to improve availability (the capacity for constant 24/7/365 operation) that includes fault tolerance. There need to be studies of ways to support offline use in times of network disturbances as well as power outages (so that users can transfer CBDC or check balances with their personal devices), and ways to avoid going offline as much as possible.

Fourth, being central bank money, CBDC should offer settlement finality and instant payment capabilities, similar to cash. Because CBDC would be expected to be used by many people for daily transactions, the system also needs sufficient processing performance to enable settlement of frequent payments swiftly and safely, and attains expandability to meet future growth in usage.

Finally, it should ensure interoperability with private settlement systems. A CBDC system needs to smoothly connect to private sector so that the private sector can offer various services by using CBDC as a payment instrument; the system also needs a flexible architecture to adapt to changes including advances in private payment services in the future.

Figure 2: Core features a CBDC should incorporate

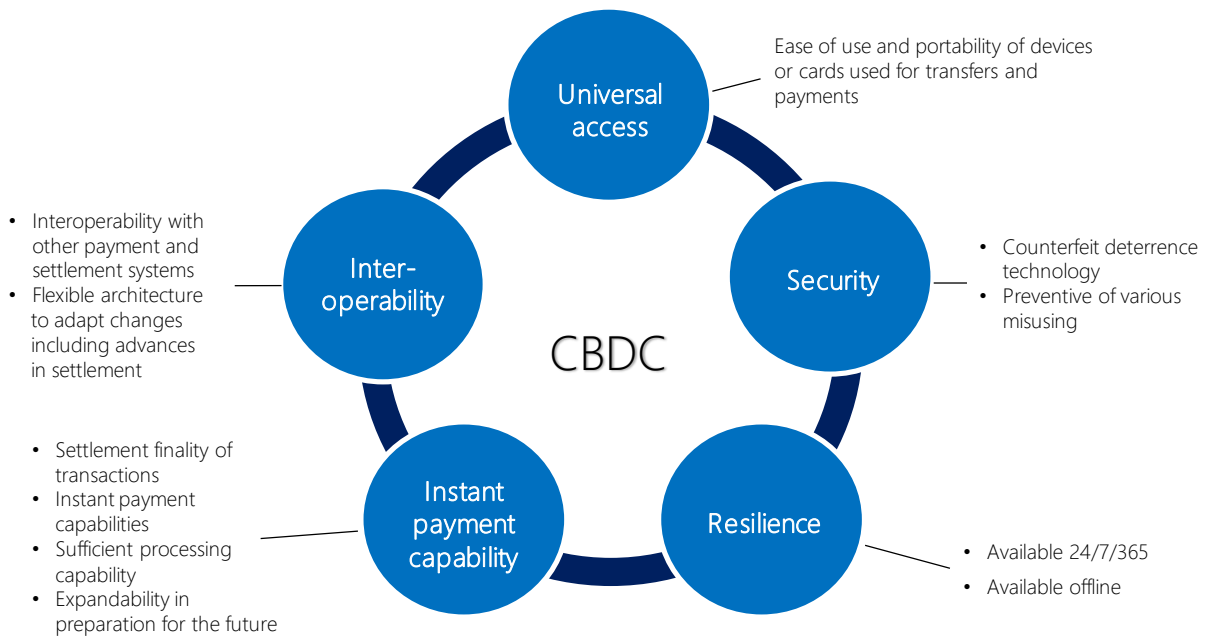

These are the core features required for CBDC. It is, however, difficult to fully incorporate all of them into CBDC when designing its institutional arrangements. For example, a CBDC that is a foundational payment instrument to the public would have adequate measures to resist security threats and system faults, but these measures would tend to impair the system’s processing performance and convenience for users, or there may need to be certain restrictions on the scope of private settlement systems with which it could interconnect. These tradeoffs would be carefully balanced and dealt with thoughtfully for establishing stable and efficient payment and settlement systems.

Also, if a CBDC were introduced, the measures that ensure universal access and the functions that enable offline payments might be rolled out in a phased manner according to the use of cash. For example, as will be discussed later, if we assume a world in which a CBDC and cash coexist, it would be possible to fall back temporarily to cash settlements in a power outage, reducing the need for a system that can handle offline transactions at the initial CBDC rollout.

1.3 CBDC issuance and distribution

1.3.1 A two-tiered payment and settlement system

Many central banks, including the BOJ, would expect to issue CBDC through a two-tiered

system comprising a central bank and the private sector (the indirect issuance model)³.

The BOJ has no experience of having direct, daily transactions with firms and individuals, and recognizes that it would be hard to address elaborately the varied needs of all users. For this reason, the BOJ considers it appropriate to focus its efforts on providing CBDC as a foundational payment instrument, and having the private sector, as “intermediaries”, fulfill the role of bringing CBDC to the public. This role-sharing makes good use of the private sector’s experience and expertise, and will improve the stability and efficiency of the CBDC system as a whole.

Figure 3: Two-tiered CBDC system

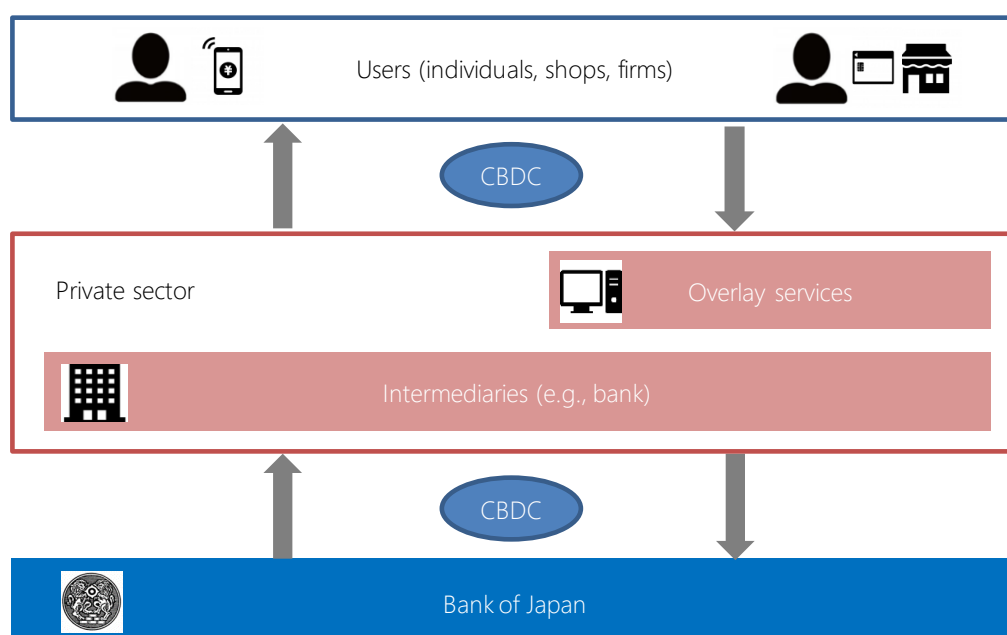

Note that, as already mentioned, CBDC is issued by the BOJ and is not issued by intermediaries as their own liabilities. The “indirect” format means that intermediaries such as banks will stand between the BOJ and users, and act as middlemen for delivering or receiving CBDC⁴. As will be discussed in more detail in Chapter 3, for the operations of intermediaries, we expect the operations of intermediaries to include onboarding of CBDC users and payouts of CBDC to users in exchange for other forms of money (e.g., users’ deposits) upon their requests.

³ Conceptually, we can also conceive of the “direct issuance model” in which a central bank transacts directly with end users, without intermediaries, but there is no inclination toward this among developed countries at least.

⁴ This is similar to the current way of cash in circulation: it is transported from the BOJ’s main office, stored in the vaults and ATMs of financial institutions, and then provided to individuals and firms.

1.3.2 Offline services

There could be two variants of CBDC services: an online service provided over computer networks, and an offline service that is cut off from computer networks.

Assuming a case where CBDC is transferred between users, in the online mode each user with their smartphones or other devices transmit transaction requests via the systems of intermediaries to a geographically remote CBDC ledger (defined later). The ledger operator (e.g., the central bank) administers the amounts of CBDC held by users, which reduces each user's administrative overhead. Benefits of the online mode are that geographically distant users can easily exchange CBDC, and by connecting the CBDC system with systems of the private sector, it is easy to provide overlay services related to CBDC. In the offline mode, on the other hand, users use their endpoint devices to communicate directly with one another in order to directly transfer CBDC, and the information is stored locally on their respective devices. This requires that each user individually administer his/her own CBDC holdings. Like cash, this would be primarily for face-to-face transactions, and compared to online mode, it is limited in terms of the overlay services that could be provided via other systems.

We can expect two approaches to offline mode: 1) Online and offline mode coexist, and users can use either one at any time; 2) Availability of offline mode is limited for certain occasions such as natural disasters, while in normal times only online mode is available. The second approach, where the scope of offline usage is set more limited and temporal, might have more flexibility for adjusting service levels (e.g., setting lower limits on transactions while relaxing security requirements) than the first approach.

These points require further discussion, but hereinafter should be assumed that CBDC is being provided in online mode, except where otherwise indicated.

1.3.3 Basic transactions

Figure 4 describes the basic transactions relating to CBDC using five terms: issuance, payout, transfer, acceptance, and redemption. Here, end users A and B (individuals or firms) have beforehand linked to a certain private entity X or Y as their respective intermediary (the following description is concerned with the case where intermediaries are banks holding current account deposits at the BOJ).

The process begins with intermediary X asking the BOJ to debit the amount from its current account deposits at the BOJ and to credit an equivalent amount of CBDC to its account or to create an equivalent amount of CBDC tokens in exchange. This is how CBDC is issued, put into circulation.

Next, CBDC is paid out to a user. User A uses a smartphone or other device to transmit instructions online to intermediary X requesting that their own deposits be debited from A’s account and that they receive a payout of an equivalent amount of CBDC in exchange. Note that this is a matter for future design, but the CBDC payout to user A is not necessarily in exchange for the deposits at intermediary X. For example, facilitating user A to receive CBDC from intermediary X in exchange for cash or deposits at an intermediary other than X could ensure more effective CBDC distribution.

Third, the CBDC is transferred. A user transmits instructions online to convey CBDC to another user to make a payment to that user (shop, individual, etc.).

Fourth, acceptance reverses the action of payout. Intermediary Y receives CBDC from user B, and increases user B’s deposited amount in exchange.

Fifth is redemption, which reverses the action of issuance. The BOJ receives CBDC from intermediary Y and credit the amount to intermediary Y’s current account deposits at the BOJ in exchange.

Figure 4: Basic transactions using CBDC

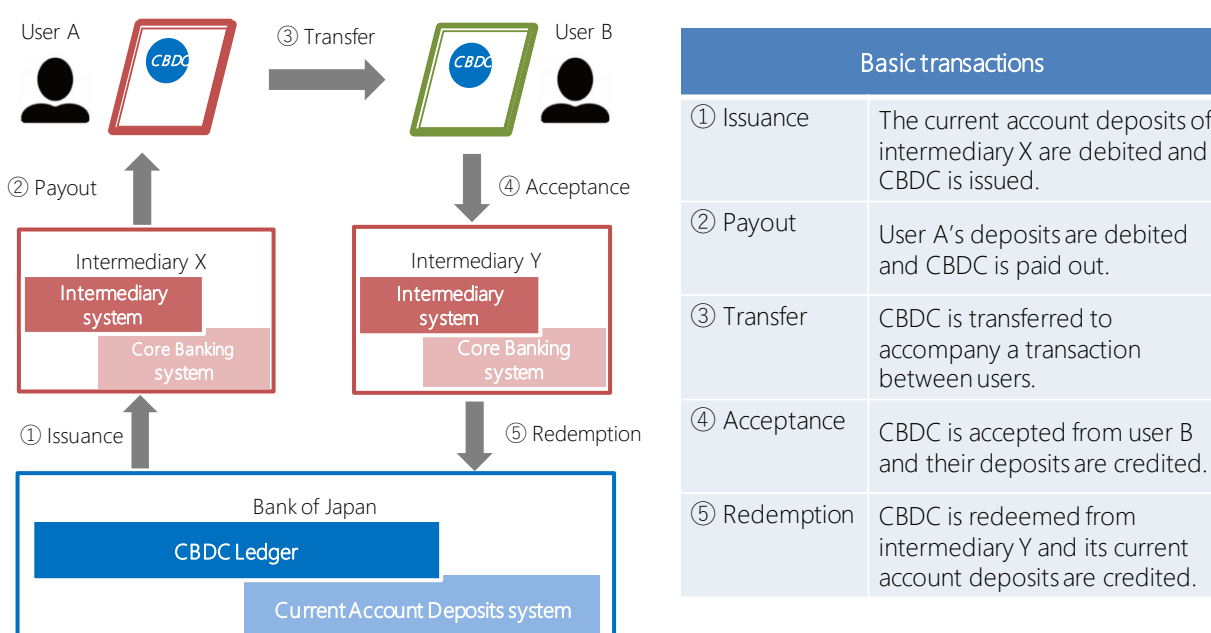

Basic transactions	
① Issuance	The current account deposits of intermediary X are debited and CBDC is issued.
② Payout	User A’s deposits are debited and CBDC is paid out.
③ Transfer	CBDC is transferred to accompany a transaction between users.
④ Acceptance	CBDC is accepted from user B and their deposits are credited.
⑤ Redemption	CBDC is redeemed from intermediary Y and its current account deposits are credited.

In this way, by converting with current account deposits at the BOJ and bank deposits, the movements that are exchanges of CBDC between the BOJ and financial institutions and between financial institutions and users wind up being similar to the way cash circulates today. The difference between the two is that in case of cash, banknotes or coins are physically delivered between the parties, while in the case of CBDC, records are changed in the CBDC ledger (described later) based on instructions transmitted online by intermediaries and users to effect transfers between the parties.

1.3.4 Balance-sheet changes

Figure 5 shows in simplified form the balance-sheet changes around CBDC issuance.

Step 1 on the upper left shows the state before CBDC is issued. When CBDC is issued, the central bank's and intermediary's balance sheets change, as shown in Step 2 on the upper right. From the intermediary's perspective, one asset— current account deposits at the central bank —is exchanged for another: CBDC.

Next, when CBDC is paid out by the intermediary to the end user, the balance sheet changes as shown in the lower pair of diagrams. First, the firm or individual obtains CBDC in exchange for cash, and the balance sheet changes as shown on the lower left in Step 3-1. Here, the user is bringing cash to an intermediary's counter or ATM, and the intermediary is paying out central bank-issued CBDC to the user in exchange. The intermediary brings the cash received from the user to the BOJ, and once that is credited to its current account deposits at the BOJ, the central bank's liability and the business/household asset complete the exchange from banknote to CBDC.

Next, in the case where a firm or individual obtains CBDC equivalent in value to money they have on deposit, the balance sheet changes as shown in Step 3-2 on the lower right. Here, the intermediary pays out central bank-issued CBDC to the firm or individual as requested by that user, and deducts an equivalent amount from their bank deposits. In this case, as long as no additional action is being taken, the intermediary's balance sheet is reduced by the amount of CBDC paid out⁵.

⁵ In cases such as Figure 5 Step 3-2, when the current account deposits at the BOJ are reduced, if required by monetary policy, the BOJ will provide funds to the market through its market operation, and as a result, increase current account deposits at the BOJ. In this case, on the intermediary's side, government bonds are exchanged for current account deposits at the BOJ assets, or the current account deposits at the BOJ assets and the liabilities such as borrowing from the BOJ both increase in a straddle.

Figure 5: Balance-sheet changes accompanying the issuance and payout of CBDC

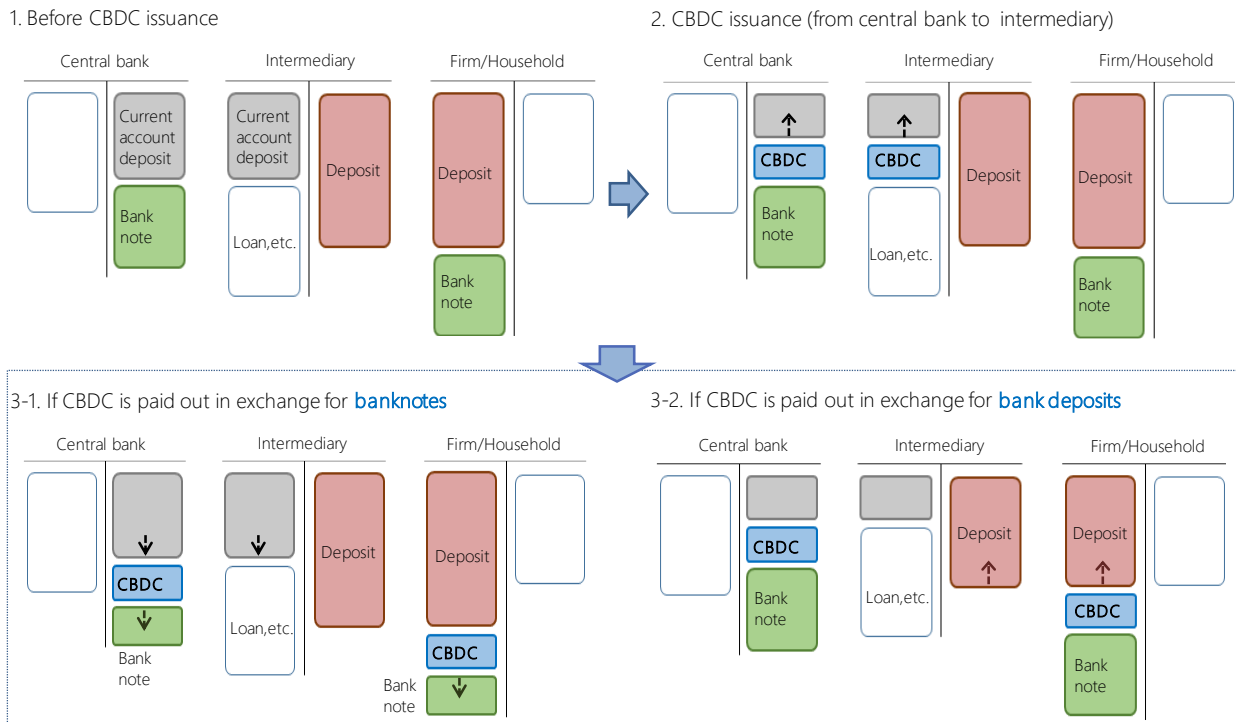

As mentioned above, CBDC is a liability of the BOJ and it serves as an asset to other entities. The role of intermediaries is to mediate between the BOJ and end users, mediating the exchange of CBDC assets. For this reason, an intermediary's solvency will have no direct impact on the value of CBDC, while there is a possibility that the distribution of CBDC will be affected if there is a failure in the intermediary's business operations. The stability in the value of CBDC is, same as for banknotes, backed by the confidence of the BOJ and its policies.

2. CBDC experiments

2.1 Proof of Concept Phase 1

2.1.1 Phase 1 overview

In line with the Approach, the BOJ has been conducting the planned technical experiments for CBDC. There are two stages to the experiments: Stage 1 is the PoC, and Stage 2 is the Pilot program involving intermediaries and end users. “Experiments” would arguably give some impressions of conducting the real-world payment experiments involving many consumers and retailers, but before these “experiments”, the BOJ needs to build the experimental environment at the system level, and confirm whether the basic ideas for CBDC are technologically feasible. This process is what we call the PoC.

Figure 6: Experiment schedule

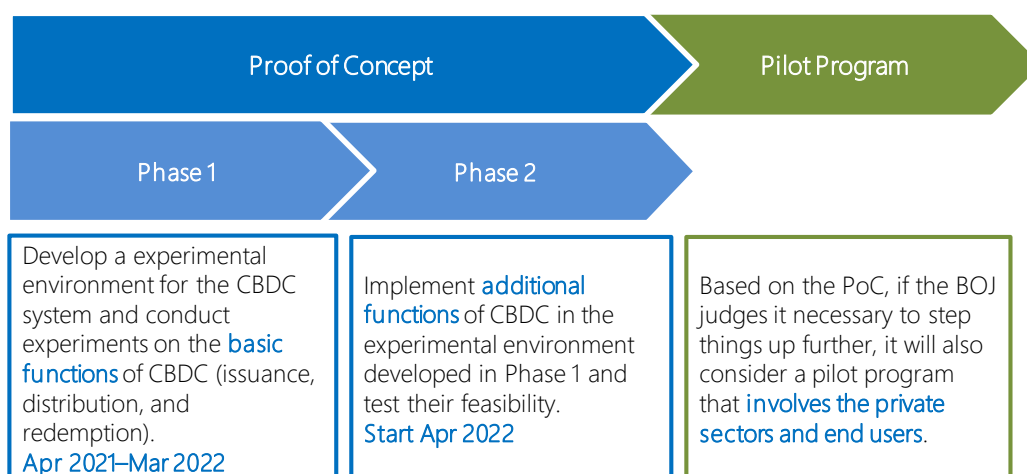

In addition to having two stages, the BOJ split the PoC into two phases, with Phase 1 starting in April 2021. In Phase 1, the BOJ built an experimental environment in the public cloud centered around a “CBDC ledger” as the foundation of a CBDC system, and evaluated whether the basic transactions relating to a CBDC (specifically, a series of transactions such as issuance, payout, transfer, etc., as described in Section 1.3.3) could be processed appropriately, and to evaluate the processing performance of the CBDC ledger and the functional aspects of reliability and ease of extension. The experiments are being conducted by the Payment and Settlement Systems Department of the BOJ, with a team of 15 people comprising the BOJ staff and staff of a contractor company selected through a bidding process.

The initial schedule for Phase 1 was for it to finish work in March 2022, and the intended goals have been achieved. Following is an overview on the experiment methods and related findings.

2.1.2 Three ledger designs

For the CBDC ledger in PoC Phase 1, the BOJ posted three design alternatives, based upon the discussions with internal and external parties. These three designs were mainly intended to analyze differences in processing performance stemming from those designs, inherited, and not necessarily to choose one of the three towards achieving a production-ready system.

The design alternatives can be classified according to two different facets. The first is whether the ledger is managed solely by the central bank or rather management is split between the central bank and intermediaries⁶. The second facet is whether the holding status is represented as “account-based” or “token-based”: the former recognizes CBDC holdings as an intermediary’s or user’s account balance, whereas the latter assigns unique identifiers (IDs) to monetary data representing fixed value (tokens⁷) and recognizes CBDC holdings by linking these IDs to user IDs. Note that in all of these cases, payments assumingly take place online, by receiving online instructions from users and recording CBDC transaction or holdings data in the remote ledgers.

Design 1 deals with an account-based ledger system in which the central bank solely manages a ledger that records balances and transactions for all users and intermediaries. The payment of CBDC is handled as an account transfer between users.

Design 2 is an account-based ledger system, with intermediaries managing ledgers that record the balances and transactions of their respective customer users, and the central bank managing a ledger that records the balances and transactions of the intermediaries. In PoC Phase1, the every intermediary has two accounts at a ledger the central bank administers; one is its own accounts, recording the CBDC balances held by the intermediaries themselves, and the other is aggregated user accounts, meaning that it records the total CBDC balances held by their customer users. Here, when CBDC transfers between two end users under different intermediaries (see Figure 8, Step 4),

⁶ Regarding the management entity of the ledger, the Bank for International Settlements (BIS) defines two models for a “Two-tier Retail CBDC”: 1) a “hybrid model” in which the central bank centrally manages a ledger that records transactions for all users, and 2) an “intermediary model” in which intermediaries manage the ledgers that record the transactions for their respective customer users and the central bank manages a ledger that records transactions at the level of the intermediary. In Phase 1, Design 1 was an example of the first model and Design 2 was an example of the second.

⁷ In this paper, we use the word “token” in the sense just described in the main text, but “token” and “tokenize” do not have formally established definitions and so may have other meanings, depending on the context.

the balances of the user's accounts managed by the intermediary and the intermediary's accounts managed by the central bank (aggregated user accounts) will rise or fall at the same time. However, with CBDC transfers within the same intermediary (see Figure 8, Steps 3 and 5), the user's account balances managed by that intermediary will rise and fall, but this will not result in any changes to the account balance for the intermediary managed by the central bank.

Design 3 covers a token-based ledger system. Two token-based systems can be possibly conceivable: a fixed-value approach, in which the token ID assigned at issuance does not change until redemption, and a flexible-value approach, in which tokens can be split or merged in transfers, and token IDs will be reassigned at those times. The fixed-value approach was used in PoC Phase1. In this approach, the movements of all issued tokens are recorded in a ledger managed by the central bank, and CBDC transfers between users are effected by changing the linkages between token IDs and user IDs in the ledger. Note that, with the fixed-value approach, transfers become more complicated if a user does not have a set of tokens matching the value of CBDC to be transferred. In PoC Phase1, these cases were handled by the intermediary performing an exchange using tokens it had on hand.

Figure 7: Ledger design alternatives

	Design 1	Design 2	Design 3
Ledger managed by	Central bank	Central bank & Intermediaries	Central bank
ID assigned to monetary data?	No (account-based)	No (account-based)	Yes (token-based)

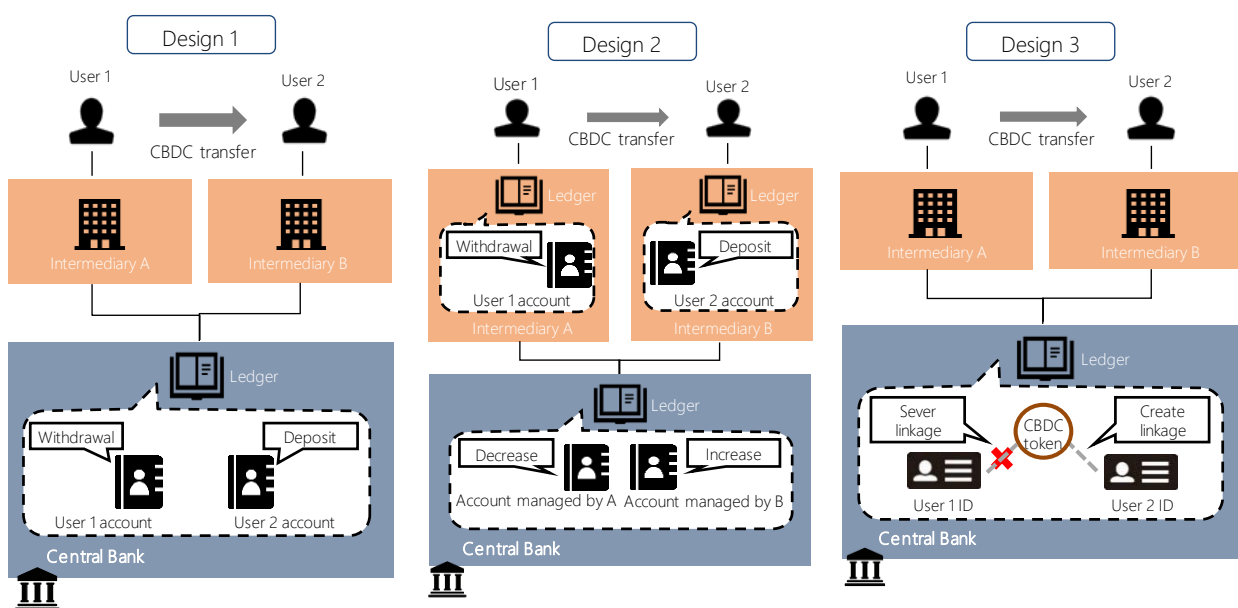

As shown in Figure 7, the three design alternatives differ in terms of where the ledger is managed and the data model (account-based versus token-based), but what is unchanged is that the CBDC is issued by the central bank. Also, under the two-tiered payment and settlement system, intermediaries play similar roles in all of the designs in the sense that they stand between the central bank and users, and mediate the receipt of CBDC among other intermediary operations (see below). In the case of Design 2, these operations also include managing ledgers.

The ledger system in these three design alternatives has a “central management scheme” in all cases, managed either by the central bank or an intermediary, rather than a “distributed ledger scheme” where a single ledger is jointly managed by the participants in the transaction.

Figure 8: Ledger management entity and CBDC transfer recording methods

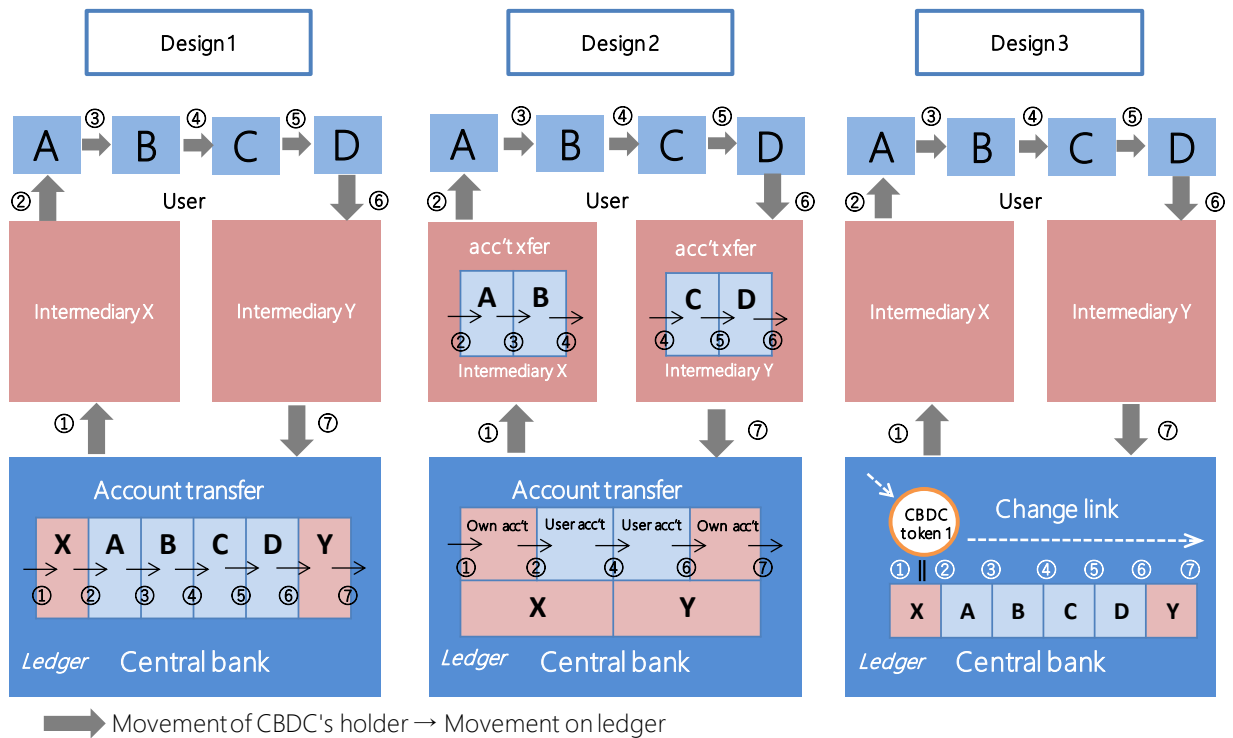

Note 1: ①: Issuance; ②: Payout; ③,⑤: Transfer within a single intermediary institution; ④: Transfer across intermediaries; ⑥: Acceptance; ⑦: Redemption.
 Note 2: In Design 2, payouts (②), transfers across intermediaries (④), and acceptance (⑥) simultaneously increase and decrease account balances on the central bank's ledger and on intermediaries' ledgers. Movements of transfers within a single intermediary institution (③,⑤) are not reflected in the central bank's ledger.

2.1.3 Experiment methods and results⁸

The goals for PoC Phase 1 were to envision requirements towards achieving a production-ready system and, through experimental works and architecture evaluation to compare and evaluate

⁸ For details on Phase 1 main results, see the “Central Bank Digital Currency Experiments Results and Findings from ‘Proof of Concept Phase 1’” (May 2022, Payment and Settlement Systems Department, Bank of Japan).

system performance and functionality using the three design alternatives.

(a) Performance evaluation

Performance evaluation methods

Performance evaluation was conducted in two stages. First, experimental works were run in which performance was measured using the experimental environment, assuming the required processing performance in introducing a CBDC in the future (production-ready system): typical throughput (the number of transactions requests that a CBDC ledger system could process per second) of several tens of thousands of transactions per second, peaks beyond 100,000 transactions per second, and latency (the time taken to process one transaction request) of within a few seconds. Second, based on those results, issues and strategies towards achieving a production-ready system were investigated in architecture evaluation. The experimental works ran each of the three design alternatives in a public cloud, using a ledger system consisting of application servers that execute the transaction requests and a database server that records and retains the resulting holding status. External to the ledgers are the wallet apps used by end users and the intermediaries' systems that would relay user instructions to the ledger; they have a simple design (mockup) that allows only the injection of transaction requests.

Figure 9: Overview of the experimental environment

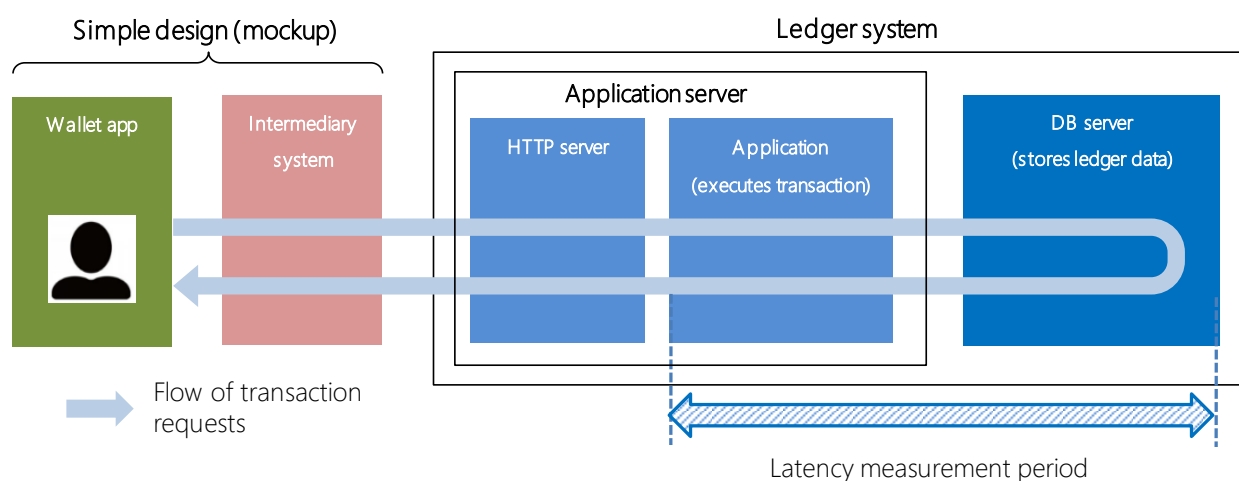

All three designs assume 100,000 end users and 5 intermediaries (2 large, 1 mid-sized, and 2 small, according to the number of end users). The breakdown of transaction requests requested via intermediary systems by type is as follows: 5% payouts, 30% transfers within a single intermediary, 60% transfers across intermediaries, and 5% acceptances. In addition, in Designs 1

and 2, each end user has their own account, and in Design 3, the total number of issued tokens is 25 million, and in a single iteration of a transaction request, the number of tokens that will be updated is 10.

To evaluate the processing performance of each design, experimental works were conducted using two scenarios: a “base scenario” in which 500 transaction requests were injected over a second, being a level each design should be able to handle without any delay of process, and a “high-load scenario” in which 3,000 transaction requests were injected over a second, being a level that should affect each design’s processing performance. Three measurements were used in both scenarios to reveal differences in each design’s processing performance and locate performance bottlenecks: 1) throughput (the number of transactions processed successfully per second by the application server’s application), 2) latency (sum of application and database processing times), and 3) resource utilization (CPU utilization rates for the application server and database server).

Performance evaluation results

Results of the experimental works were as follows. In Design 1, even in the high-load scenario, throughput of 3,000 transaction requests per second, which was equivalent to the target rate set for transaction requests, was achieved and latency in both t base and high-load scenarios stayed about the same, at roughly 10 milliseconds. The database server’s CPU utilization rate under the high-load scenario was about 30%, showing plenty of headroom.

Figure 10: Performance evaluation results

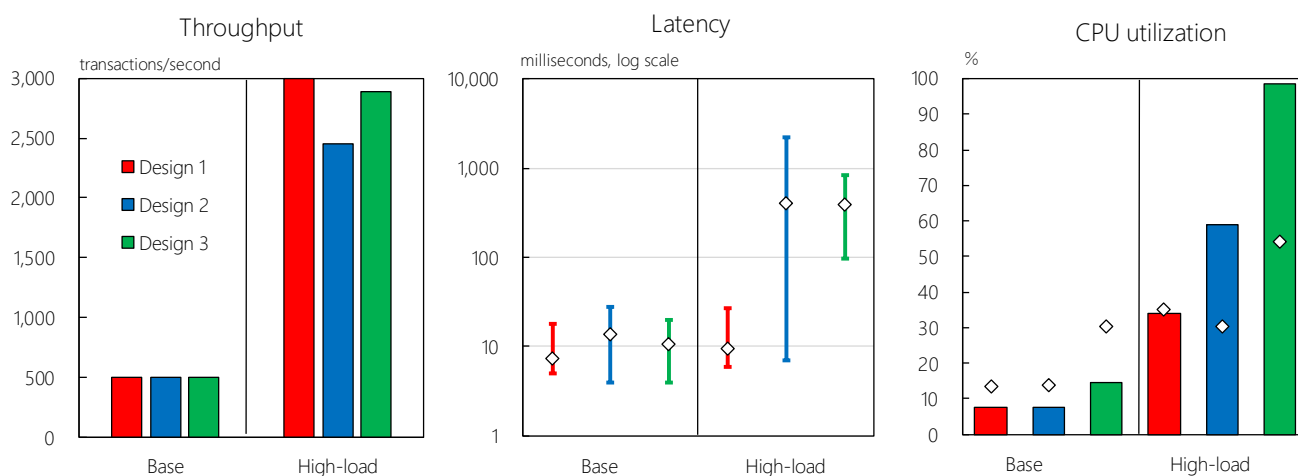

Note: Figures are average values for the measurement period. Latency shows ranges from the 1st to 99th percentiles, with averages indicated by \diamond . CPU utilization is for the central bank’s ledger, with bars indicating values for the database server and \diamond the application server.

In Design 2, the throughput dropped by 18% relative to the transaction requests under the high-load scenario, because of record locking accompanying concentration of processing in account-balance data. If there are multiple transaction requests that update account-balance data (record), records are locked so that a later transaction cannot be processed until the earlier transaction is complete (record locking). In Design 2, with requests for transfers across intermediaries (Figure 8, Step 4), there is a transfer between user accounts on the intermediary ledgers and at the same time, a transfer between intermediary accounts on the central bank's ledger (specifically, the aggregated user account), and we saw concentration of transaction requests on intermediary accounts, resulting in processing slowdowns. The processing delay incurred by this record locking increased latency for Design 2 (about 2,000 milliseconds for the 99th percentile) compared with Design 1, and database utilization rates climb to about 60% due to record-locking controls. Thus, Design 2 consumes more resources than Design 1.

In Design 3, the high-load scenario raised CPU utilization to nearly 100%. The main factor behind this is that for each transaction instruction, holder ID updates were processed for multiple tokens, and because exchange processes happen for a constant fraction, the number of processes ballooned compared with other designs. Because of these resource constraints, the throughput dropped by 4% relative to the transaction requests, and the latency increased (about 800 milliseconds for the 99th percentile) compared with Design 1.

[Performance issues towards achieving a production-ready system](#)

The performance evaluation revealed two bottlenecks that would need to be addressed to achieve the processing performance necessary in a production-ready system (tens of thousands of transactions per second typically, 100,000 or more under peak load, and latency of no more than a few seconds): the impact of record locking and resource constraints.

The performance evaluation results showed that the record locking in Design 2 brought about performance bottleneck, but it could arise in Design 1, which is also account-based, depending on the number of transaction requests. One possible strategy for mitigating the impact of record locking is "record splitting," where the account-balance data recorded in the CBDC ledger are split into multiple parts. Another option is to redesign the business process flow (in Design 2, when processing requests for CBDC transfer across intermediaries, relaxing the simultaneity requirement of the central bank ledger transfer and the intermediary ledger transfer).

Figure 11: Effects of bottlenecks (simplified)

A. Impact of record locking

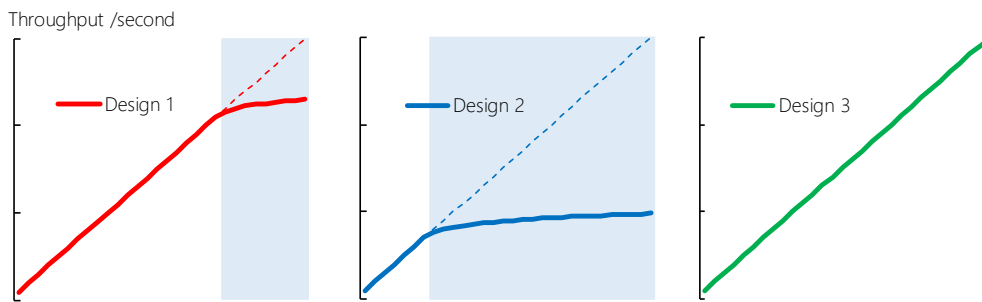

B. Impact of resource constraints

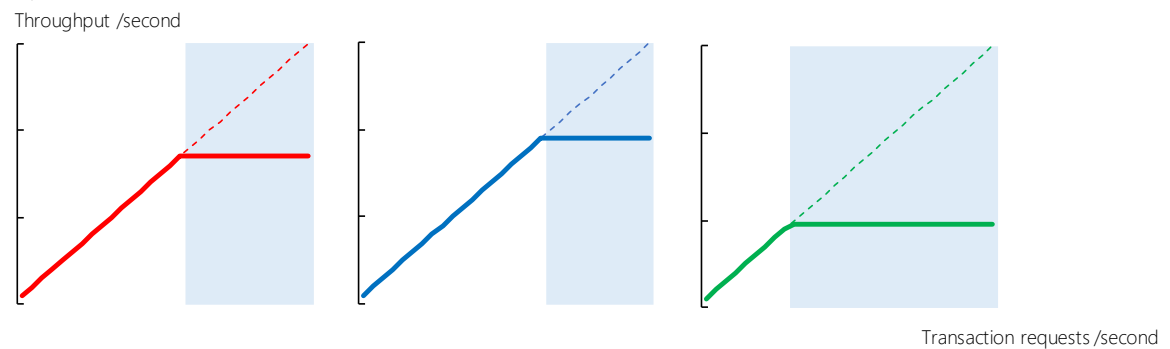

Note 1: The graphs approximate the relationship between transaction requests and throughput. Design 2 is for the central bank's ledger.

Note 2: The shaded areas indicate where a bottleneck is causing throughput to decline relative to the number of transaction requests. The dotted lines show the extrapolated curve without the bottleneck.

Note 3: All graphs for A and B exclude any reciprocal effects.

The impact of resource constraints was most apparent in Design 3, but Designs 1 and 2 could face the same problem, depending on the number of transaction requests. There are two ways to tackle this problem: scaling up (increasing server's processing performance) and scaling out (adding more servers). We can calculate that relying on scaling out alone to solve resource constraints in a production-ready system (assuming a throughput of 100,000 transactions per second) would require approximately the same number of database servers (for the central bank's ledger) for Designs 1 and 2, but two to three times as many for Design 3. When increasing the number of database servers, it is necessary to carefully optimize the design and layout of the databases, so as to avoid deterioration in throughput and latency due to transaction requests being concentrated in certain records.

In a production-ready system, there could be bottlenecks outside the scope of this experimental work (network bandwidth, storage I/O performance, etc.). There could also be scenarios unlike the ones we tested, such as temporary and localized extreme loads. Additionally, it would become necessary to meet additional needs such as implementing increasingly complex additional

functions and sufficiently dealing with security risks. A production-ready system would need to fully account for all these factors in order to design and build a suitable system.

Summary of performance evaluation

The following summarizes the main results of performance evaluation for each design.

Processing perform lower in Design 2 compared with Design 1 due to the effects of record locking. That said, Design 1, which is also based on an account-based ledger system, could experience the similar lower performance depending on the number of transaction requests. In order to build a production-ready system, we would need to consider solutions such as split records and different business process flows to address these issues.

Design 3 required more resources than Designs 1 and 2 to process the same transactions. Designs 1 and 2 will be constrained by resources if the number of transaction requests is up significantly. In a production-ready system, Design 3 in particular would need greatly expanded resources with the additional optimizations.

(b) Functional evaluation

In addition to the performance evaluation described above in (a), functional evaluation of each design were also conducted as part of PoC Phase 1. Specifically, architecture evaluation was used to compare and evaluate each of the designs for the reliability (resistance to security risks, fault tolerance, and availability) and ease of extension that would be needed in a CBDC ledger system if it were built out as a production-ready system in the future. The results were as follows.

Regarding resistance to security risks (resistance to cyberattacks) and availability (the frequency and duration of system downtime), no significant differences were observed resulting from the differences between the design alternatives.

Regarding fault tolerance (the number of potential failure points and the scope of their impact), Design 2 is thought to have a relatively small expected impact area for faults, compared with Designs 1 and 3. However, it has more potential failure points, and the integrity of restored data is unlikely to be hold.

Regarding ease of extension (ease of implementing additional functions), each design has its distinct qualities, but whether major differences exist among them remains yet to be determined.

2.2 Proof of Concept Phase 2

2.2.1 Phase 2 overview

The BOJ began PoC Phase 2 in April 2022, following Phase 1. The purpose of Phase 2 is to implement more complex additional functions to the basic CBDC functions in Phase 1, as well as to explore their technological feasibility and processing performance. At the moment, Phase 2 is expected to last one year, ending in March 2023.

In Phase 2, an experimental environment will be developed on the CBDC ledger by adding-on some systems necessary for evaluating additional functions. Design 1 will be the primary scope in the experimental works for the ease of implementing additional functions to the CBDC ledger. Design 2 shares a number of aspects with Design 1 and we could supplement the experimental work with architecture evaluation to grasp the differences between these design alternatives. Additional studies related a token-based ledger including Design 3 will be underway if needed to explore its differences in terms of function and performance compared with an account-based ledger.

As in Phase 1, the experimental environment is built in a public cloud, and the systems that are external to the CBDC system, including those for current account deposits at the BOJ and the core banking systems of intermediaries, have simple functions (mockups) that only generate transaction requests to the ledger.

The members of the Liaison Committee have floated many ideas about what form a ledger system should take in a future where CBDC is introduced to Japan. For example, on the subject of comparing different ledger design alternatives, they have brought up whether there is a single point of failure, flexibility in the roles of financial institutions, load volume of building and operating the systems at intermediaries. Design 3 is intriguing from a technological standpoint, but has a lot of potential problems and seem to be relatively difficult to overcome.

The BOJ has made no decision about what sort of ledger system it might adopt. That choice will require consideration of a number of factors, including system processing performance and reliability, as well as the cost of developing and operating the ledger, and developments in other countries. In fact, many other countries are currently studying a number of different underlying technologies for CBDC ledgers. Work continues on exploring and acquiring information on hybrid of Designs 1 and 2, as well as token-based systems (including both flexible-value approaches and

the fixed-value approach in Design 3), without any prejudice.

2.2.2 Experiment topics

In Phase 2, additional CBDC functions are being categorized into three blocks based on their affinity in IT system development. Specifically, functions are categorized as 1) functions that contribute to improving the convenience of payments; 2) economic designs for CBDC (limits on use that ensure the stability of the financial system); and 3) functions for coordination among intermediaries, or between the CBDC system and external systems. Experimental work is expected to proceed on these blocks accordingly (defining requirement, development, experimental work, and architecture evaluation). Note that none of these functions will necessarily be implemented in the future; one of the goals for Phase 2 is to prepare for future discussions of institutional arrangements by learning beforehand where the technological problems lie and what is technologically difficult or easy to implement.

Figure 12: Main experiment topics for Phase 2

	Functions being explored	Related systems built for experiment
Improving convenience of payments	<ol style="list-style-type: none"> 1. Booking remittance instructions by users in advance 2. Batch remittances or “reverse lookup” remittances at user request 3. Ways to connect online CBDC and offline CBDC (charge/discharge) 	<ul style="list-style-type: none"> • Accept and manage reservations for remittance instructions • Load distribution for batched remittances
Economic design <small>Safeguards ensuring the stability of the financial system</small>	<ol style="list-style-type: none"> 1. Limits on CBDC holdings 2. Limits on CBDC transaction amounts (per transaction or per time period) 3. Limits on number of CBDC transactions (per time period) 4. Applying interest to CBDC holdings 5. Applying different limits based on user attributes 	<ul style="list-style-type: none"> • Manage holdings history • Manage transaction history (amounts, iterations) • Calculate & pay interest • Manage details of per-user limits
Coordination among intermediaries/with external institutions	<ol style="list-style-type: none"> 1. Providing multiple accounts to one user via multiple intermediaries 2. Name-based aggregation for multiple accounts 3. Ways to connect private settlement services, public system, etc. 4. Ways to exchange cash and CBDC 	<ul style="list-style-type: none"> • Manage number of accounts held • Calculate holdings after name-based aggregation

In Phase 2, one of the goals is to evaluate whether the above functions are executed appropriately and what effect these functions—in particular holdings limits and transaction limits that can restrict CBDC processing of funds transfer—will have on system performance. Specifically, as in Phase 1, transaction request will be injected under a variety of scenarios and transaction throughput, latency, and resource utilization in the ledger system will be measured. Then, based

on the results, the BOJ will investigate what strategies and methods of resource expansion would be needed to achieve the performance requirements of a production-ready system.

Additionally, on the assumption that multiple additional functions might be implemented, there will be a study (mostly through architecture evaluation) of problems and solutions relating to resistance to security risks, fault tolerance, and availability.

2.3 Next steps

The following points are issues that may need to be addressed in the future, in parallel with Phase 2.

2.3.1 Pilot program

As stated in the Approach, based on the PoC, if the BOJ judges it necessary to step things up further, it will consider a pilot program that involves the private sector and end users.

Assuming that it takes place, there are a number of possible ways that the pilot program could be conducted. Looking at examples from other countries, there are cases where test systems are designed with their utilization as production systems in mind, and from an early stage, the experimental environments were built at a large scale. However, there are also cases of starting with small-scale systems to focus on test objectives. In the latter cases, participants of the pilot program would be initially limited, then the scope and the participants would be expanded in a phased manner.

The BOJ will make a decision about whether to conduct the pilot program after exchanging opinions with other stakeholders on what topics should be considered in advance (for example, what the experiment topics are and what ledger technology is to be used), and, assuming it does decide to move forward, how intermediaries, other private businesses, private payment and settlement infrastructure, and end users such as retailers and individuals can be involved.

2.3.2 Research and study on elemental technology

In order for a CBDC to be widely used as a foundational payment instrument to the public, there are elemental technologies that it would need to incorporate: 1) cybersecurity and information security; 2) user authentication (including biometric authentication); and 3) endpoint devices (wallet apps and card-like devices). These technologies lie outside the implementation for

the PoC, but the BOJ will conduct research into these in parallel and consider implementing these technologies in series in the future trials as needed. The BOJ sees it as important for that process to be informed by the technology and knowhow of companies in a range of businesses, through venues such as the Future of Payments Forum.

2.3.3 Follow-up of developments abroad

Looking at the developments in major economies on general purpose CBDCs, there are ongoing exchanges of views among stakeholders and technological testing, including a discussion paper laying out the topics for study in terms of policy in the United States (Jan 2022, The Federal Reserve) and a report on underlying technologies for CBDC ledgers (Feb 2022, The Boston Fed and MIT), as in China and the euro area.

Also, a CBDC Coalition⁹, seven central banks including the BOJ participate, and has vigorously analyzed and investigated CBDC institutional arrangements and advanced technologies. Based on these activities among the major economies, the BOJ sees it as important to widely share findings on ways to build CBDC ledgers and elemental technologies and utilize these findings its own investigations.

⁹ The member states are Japan, the United States, the Euro Area, the United Kingdom, Canada, Switzerland, and Sweden, and also is included the Bank for International Settlements, which in Jan 2020 formed a “group to evaluate the feasibility of central bank digital currencies by major economies.” A report on the group’s activities appears later in the Reference section.

3. Investigation of institutional arrangements

The Approach states that, in parallel with the CBDC experiments, the exploration of institutional arrangements will be conducted with four main themes: (1) how central banks and the private sector should cooperate and share roles, (2) the relationship with financial system stability, (3) ensuring privacy protection and handling of user information, and (4) the relationship with cross-border payments.

Of these themes, the Liaison Committee discussed (1) and (2) from the perspectives of "vertical coexistence" and "horizontal coexistence." This chapter introduces the BOJ's current understanding on these themes and the discussions at the Liaison Committee.

3.1 Entities constituting the CBDC system and their roles: vertical coexistence

3.1.1 "Foundational payment instrument" and "overlay services"

As a premise for exploring the relationship between a central bank and the private sector, it is helpful to divide the CBDC system into two areas: the infrastructure part to provide all users equally with CBDC as a "foundational payment instrument" and, the "overlay services" part that meet user needs on top of the infrastructure part in which CBDC works as a public good.

Figure 13: "Foundational payment instrument" and "overlay services"

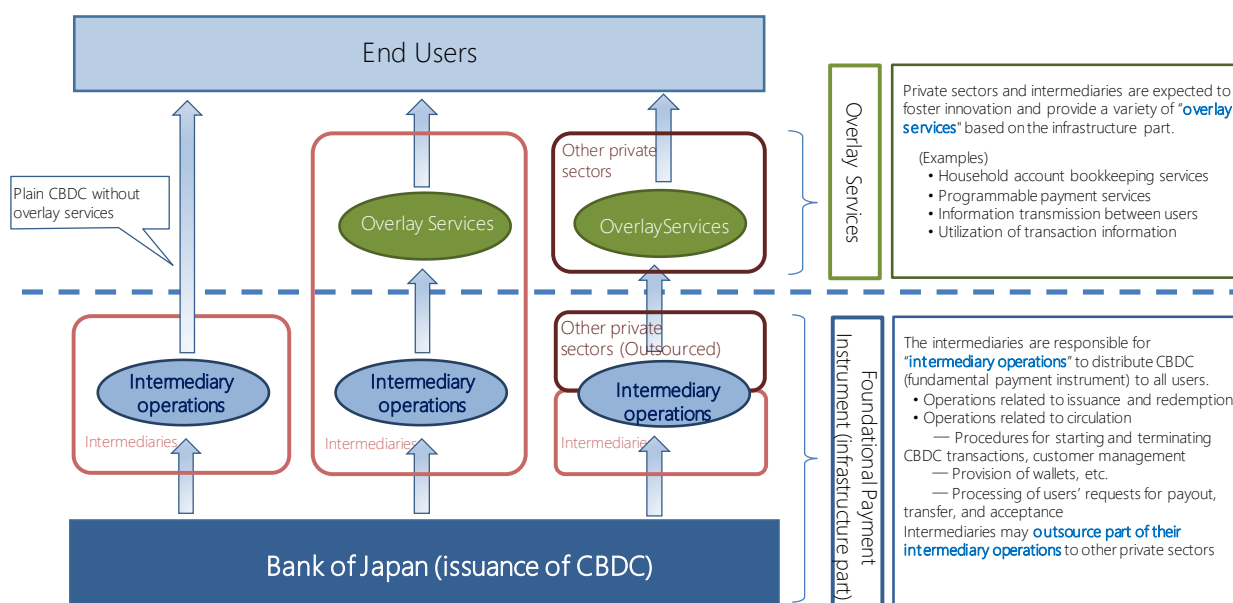

The entities for infrastructure part consist of the BOJ and the intermediaries. While each intermediary is expected to exercise its ingenuity to expand the number of CBDC users (who could form its own customer base), it is required at the same time to conduct its "intermediary operations" under certain rules as an entity responsible for distributing CBDC as a public good. In this sense, such operations by intermediaries can be basically sorted out as being in a "non-competitive area." CBDC itself is expected to be a foundational payment instrument, available only for simple transactions with intermediaries and users.

In addition to the basic use of CBDC, the private sector could provide various "overlay services" in order to meet the needs of end users (e.g., household account bookkeeping services to record and manage the amount and use of CBDC). Such a service differs from the one for existing cash and is unique to the digital society. In such a "competitive area," private-sector innovation and the creation of new businesses and services would contribute to the convenience of the public, the efficiency of the payment and settlement systems, and the sustainability of the CBDC system as a whole.

From the user's perspective, the boundary between CBDC as a foundational payment instrument and overlay services using CBDC is likely to blur, as both are often provided integrally with a single app in smartphones. However, depending on whether the service falls under the category of intermediary operations (infrastructure part) or overlay services, its position in the CBDC system will vary, including its relationship with the BOJ, the degree of discretion the position has in providing services, how it handles user information, and how it bears the cost burden. An opinion was raised at the Liaison Committee that an appropriate division of roles between CBDC as a payment instrument and additional private payment services would lead to the creation of an efficient payment and settlement systems through avoiding overlapping investment. In light of these points, it is considered necessary to clearly distinguish between the two areas when designing CBDC's institutional arrangements onward.

In this way, rather than a "two-tiered structure" made up of the BOJ and the private sector, it may be more appropriate to view the CBDC system as a "multi-tiered structure" in which the operations and services of the private sector are further divided into an "infrastructure part" and an "overlay service part" and these parts are piled up. In any case, the "vertical coexistence" of the BOJ, intermediaries, and other private businesses will make it possible to achieve the functions and features required for CBDCs (see Section 1.1), namely, "a foundational payment instrument alongside cash" and "development of payment and settlement systems suitable for the digital

society.”

The following outlines the main entities of the CBDC system and their roles.

3.1.2 Roles of the BOJ

The BOJ shall issue CBDC centrally as its own liabilities. It will also manage and operate the entire CBDC system as the issuer of CBDC or as the central bank responsible for the stable and efficient operation of Japan's payment and settlement systems. Specifically, in addition to establishing and administering the system infrastructure (e.g., ledgers) necessary for the issuance and circulation of CBDCs, it is envisioned to formulate and implement basic rules for the administration of CBDCs, in cooperation with the government and other authorities.

3.1.3 "Intermediary operations" by intermediaries

(a) Concept of intermediary operations

Intermediaries are responsible for the "intermediary operations" necessary to provide CBDC to users. Specifically, the intermediaries will conduct operations related to the "issuance" and "redemption" of CBDC by the BOJ, and will also conduct operations related to the circulation of CBDC for the user. With regard to the latter, main tasks would include the following: (i) procedures for customers to start or terminate using CBDC; (ii) provision of wallets services for users (e.g., smartphone apps); (iii) processing of requests from users regarding "payout," "transfer," "acceptance," "balance inquiry," etc. (relaying online instructions to and from the BOJ); and (iv) daily customer management and support. In addition, as in Design 2 of the PoC Phase1, depending on the ledger design, the intermediaries may manage the ledger that records the transactions of its own end users for the BOJ, in which case the management and operation of the ledger would also be included among the intermediary operations.

While the intermediaries, along with the BOJ, will be responsible for providing CBDC to users, they may also benefit from being actively involved in intermediary operations by (i) maintaining and expanding their customer base, (ii) reducing cash handling costs, and (iii) providing overlay services by utilizing their position as intermediaries. In addition, although it depends on the relevant institutional arrangements, it may be possible to utilize the transaction information obtained through intermediary operations and overlay services for their own business and its expansion.

(b) Scope of intermediaries

Ensuring the quality of intermediary operations at an appropriate level is essential for CBDC to function as a foundational payment instrument to the public. Therefore, in order to become intermediaries, an institution must meet requirements to properly perform intermediary operations.

For example, providing assets that are to be exchanged for the "payout" or "acceptance" of CBDC and smoothly exchanging them with users is an important role required for intermediaries. In this regard, banks and other financial institutions are considered to be promising candidates for intermediaries, given that from a large number of customers they already accept deposits (which are exchanged for CBDC in payouts and acceptances) and their generally high administrative capabilities. In selecting eligible intermediaries, careful considerations would be required based on specific criteria related to administrative capabilities, business conditions, and IT system management and operation. Although dependent on the CBDC's institutional arrangements in the future, it is not necessary to require users to have a deposit account with their own intermediaries in order to use CBDC, as there are various possible assets that could be exchanged for CBDC payouts/acceptances. Therefore, the pros and cons of admitting non-bank PSPs such as fund transfer service providers as intermediaries will also be subject to future discussion.

(c) Structure of intermediaries

The left-hand side of Figure 14 shows a "single-layer structure," in which all intermediaries serve as the BOJ's counterparties for "issuance" and "redemption" while, at the same time, responding to requests from users for "payouts" and "acceptances."

Instead, there could be an alternative structure in which some intermediaries are solely responsible for "issuance" and "redemption" to and from the BOJ, whereas other intermediaries deal exclusively with users. This is the "multi-layer structure" shown in Figure 14 right. In this case, the "first-layer" intermediaries would be the "issued" counterparty for CBDC, and the "second-layer" intermediaries would receive CBDC from the first-layer intermediaries and payout the CBDC to its own users (in this case, the intermediaries that make up the infrastructure part shown in Figure 13 would be made further multi-layered).

Figure 14: Structure of intermediaries

(1) Single-layer structure

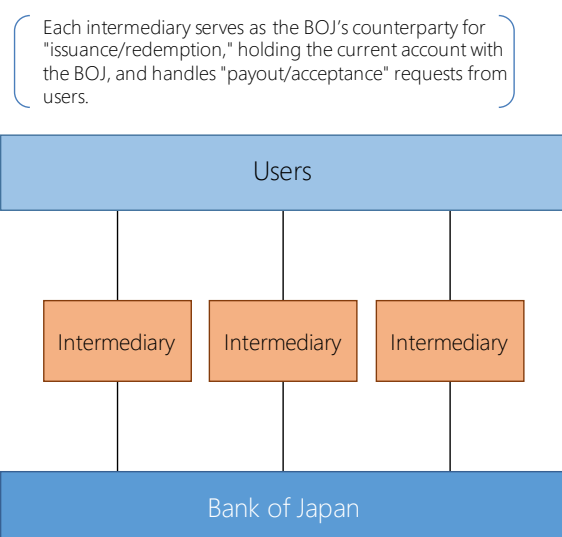

(2) Multi-layer structure

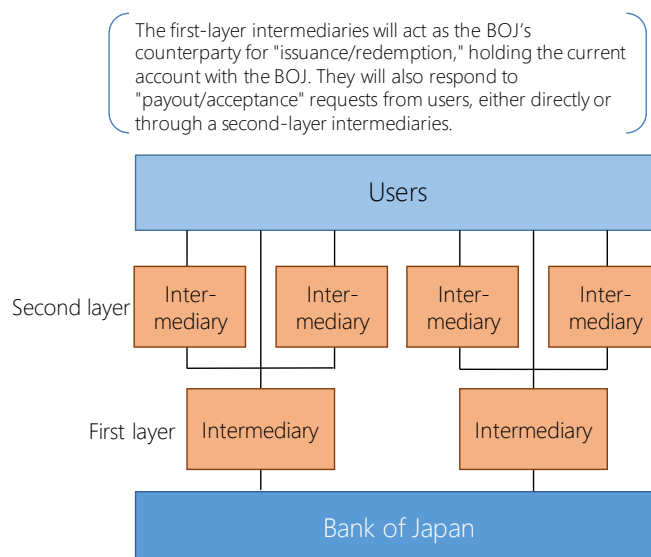

With a variety of business types and sizes, a single-layer structure in which all intermediaries assume the identical operations and equal responsibilities might not be very workable. While governance related to intermediary operations may become more complicated with a multi-layer structure, it has the advantage that various types of private businesses can be involved in the circulation process of CBDCs based on their own businesses and preferences. Related to this, an opinion was raised at the Liaison Committee that, from the perspective of allocating the cost burden of intermediary operations and achieving universal access, it would be desirable to allow a multi-layer structure that includes intermediaries other than banks, instead of making only financial institutions holding BOJ current accounts perform all of intermediary operations.

Furthermore, in relation to the CBDC ledger design discussed in the PoC Phase 1, the intermediaries will not manage the ledger in the case of Designs 1 and 3, regardless of whether a single-layer or multi-layer structure is adopted. In the case of Design 2, it is assumed that the intermediaries manage part of the CBDC ledger, and, one idea should be that only the "first-layer" intermediaries undertake the ledger management and thereby record account balances and transactions for "lower-layer" intermediaries and end users, in light of their roles under a multi-layer structure.

Since the structure of intermediaries is foundational to the institutional arrangements for CBDC and will affect how the experiments are conducted in the future, the BOJ will give thorough consideration to this issue, taking into account the opinions of all stakeholders.

(d) Outsourcing of intermediary operations

In order to facilitate the smooth provision of CBDC to end users, intermediaries could outsource part of their intermediary operations as necessary. For example, outsourcing their operations such as "development and operation of end-point devices and applications for users" and "daily customer support" to other PSPs or business firms could enhance convenience for users and cost savings for the intermediaries. It is conceivable that multiple intermediaries could jointly outsource their operations to a single private business. Such outsourcing contractors could then leverage their own technology and knowledge to find their business opportunities with CBDC, a new payment system.

3.1.4 Provision of "overlay services" by the private sector including intermediaries

As mentioned above, in order to build stable and efficient payment and settlement systems suitable for the digital society, private businesses are expected to provide a variety of overlay services that meet the individual needs of users based on CBDC as a public good.

The starting point of the discussion is that overlay services can, in principle, be provided freely by any entities within the scope of relevant law and regulations. It is also possible for intermediaries, solely or jointly (e.g., as the financial industry as a whole), to provide overlay services apart from their intermediary operations.

While a variety of ideas are thinkable, the following list illustrates typical examples of overlay services which are currently discussed among stakeholders. In the meantime, an opinion was raised at the Liaison Committee that in order to explore an environment in which the public can take full advantage of the features of CBDC through the provision of such overlay services, it is necessary to consider the appropriate design of the operational scope of the private businesses, including a flexible application of the related laws on regulating their scope of business.

- (a) Those that enhance customer convenience of use and handling of CBDC (e.g., household account bookkeeping services, setting lower upper limits on usable CBDC amounts for underage users)
- (b) Those that assist CBDC payments (e.g., providing CBDC with "programmability").
- (c) Those that enable CBDC payments with function of information transmission (e.g., EDI and bill relaying services)

(d) Those that utilize customer data acquired through CBDC transactions for new businesses and services (e.g., analyzing transaction information acquired with customer consent to develop value-added services that meet their specific needs).

Furthermore, in order to refer to the payment information necessary for providing overlay services or to retrieve such information to be utilized for other businesses, a mechanism to give access to and build smooth linkage with the CBDC's core system is required. API technology will play an important role in achieving such collaboration. In addition, "distributed ledger technology" might be useful for the private sector to provide overlay services, while depending on their contents. Thus, the introduction of CBDC might contribute significantly to the further development of related technologies.

3.1.5 Other issues

(a) Private payment infrastructure

Given that CBDC also has the aspect of a funds transfer platform in the retail field, it is necessary to make clear its relationship with the existing private payment infrastructure that processes retail funds transfer among banks in order to stimulate the discussion. An opinion was raised at the Liaison Committee that "it would be preferable to consider medium- to long-term collaboration between the CBDC system, the Zengin system (interbank clearing system for domestic funds transfers) and Cotra (small value funds transfer services) on the premise of their coexistence."¹⁰

In this regard, it would be appropriate to proceed with the following aspects.

First, from the perspective of ensuring the stability and efficiency of Japan's payment and settlement systems as a whole, it is necessary to consider adequate collaboration, taking into account that the next replacement of the Zengin system is scheduled for 2027.

Second, in order to achieve an appropriate division of roles between the private payment infrastructure and the CBDC system and to minimize investment costs, both of them would need to be built up as a flexible and efficient system respectively to accommodate various future options.

Third, if CBDC is introduced in the future, it will also be important to take an approach such that private payment infrastructures can support intermediary operations or provide "overlay

¹⁰ At the 3rd Liaison Committee Meeting (April 13, 2022), a presentation was given by the Japanese Banks' Payment Clearing Network on next-generation of retail payment systems (initiatives related to upgrading the Zengin system).

services" to CBDC users, by utilizing its existing functions (confirmation of payee, EDI<Electronic Data Interchange> functions, etc.). Such approach can be seen as an example of "vertical coexistence," which would not only improve convenience for users but also contribute to the effective utilization of resources for private payment infrastructure.

In addition, a member of the Liaison Committee commented that, as an example of collaboration between the CBDC system and private payment infrastructure, CBDC could also be used for funds clearing among financial institutions that serve as intermediaries, which could lead to the utilization of existing infrastructure and reduction of investment burdens. In relation to this point, another member pointed out that from the viewpoint of promoting innovation, it is important to timely upgrade the basic infrastructure as necessary while ensuring transition period, as in the case of mobile communication systems whose standard setting and generational transitions are orderly planned and accordingly implemented, and that coexistence with CBDC will enable existing payment infrastructure such as the Zengin system to enhance its functions and restrain its costs.

(b) End users

As mentioned above, "universal access" is one of the core features that a general purpose CBDC should retain. Therefore, any discussion should start by assuming that every individual, firm, or shop in Japan that wishes to use CBDC may do so. The domestic use of CBDC by non-residents, such as sightseeing visitors to Japan, should also be discussed.

From the perspective of ensuring user convenience and the stable operation of the payment and settlement systems, it might be an option that the framework allows a single user to designate multiple financial institutions as his/her intermediaries. In addition, in light of approaches in other countries, it might be necessary to consider in the future differential setting in CBDC services (e.g., upper limit of holding and transaction amounts) based on the attributes of users (e.g., individuals or firms).

(c) Government

The government, being responsible for currency and financial supervision, needs to establish laws and regulations necessary for the operation of the CBDC system.¹¹ It is also necessary to

¹¹ According to the government's "Basic Policy on Economic and Fiscal Management and Reform 2021" (Honebuto-no Houshin, June 2021), "With regard to CBDC, the Government and the Bank of Japan will outline the system design based on the results of the Proof of Concept to be conducted by the end of FY2022, and will consider a pilot program and the

consider the specifics of how other public services are to be provided when CBDC is introduced.¹²

(d) IT firms, etc.

The CBDC system will be built up by combining various technologies available at the time, from ledgers to endpoint devices, and such efforts will continue incessantly into the future after the CBDC is introduced. It was pointed out in the Liaison Committee that there are numerous technical issues with the CBDC system, including the coordination between the infrastructure part and overlay services, the relationship with cross-border payments, and all stakeholders, including the IT industry hold a high level of interest in issues such as what kinds of architectures should be adopted to build up a computer system that connects all of central banks, intermediaries, and other relevant service providers.

The BOJ also recognizes that IT firms and experts to be involved in the administration and operation of the system infrastructure and in the provision of elemental technologies will play an important role in supporting the stable operation of the CBDC system in the future. Based on this recognition, the BOJ has established and regularly held the Future of Payments Forum to carry out discussions with a wide range of stakeholders. In the past year, we have held a Digital Currency Subgroup on the topic of "Technologies to Support CBDC," where the private sector, especially non-financial firms, have been invited as presenters to actively exchange opinions on the latest development of technologies for accomplishing the core features required for CBDC (see Section 1.2).¹³

3.2 Relationship with other types of payment instruments: horizontal coexistence

When considering the introduction of CBDC, it is necessary to aim for achieving "horizontal coexistence" as well as "vertical coexistence" as described in Section 3.1; i.e., CBDC and other types of payment instruments (cash, bank deposits, private digital money, etc.) should properly fulfil their functions and roles and thereby coexist with each other. In order to realize such horizontal

feasibility and legal aspects of CBDC issuance"

¹² The G7 report (October 2021) lists "payments to and from the public sector" as the topic of one of the public policy principles for retail CBDCs: "Any CBDC, where used to support payments between authorities and the public, should do so in a fast, inexpensive, transparent, inclusive and safe manner, both in normal times and in times of crisis."

¹³ Since June 2021, the BOJ has held three times Future of Payments Forum Digital Currency Subgroup meetings on the topic of "Technologies supporting CBDC" as follows. First session: June 11, 2021 ("Security," "Universal access," and "Standardization of information technology" as themes); second session: November 29, 2021 ("Resilience of payment infrastructure" and "Promptness in payment services"); third session: January 11, 2022 ("Digital currency and programmability" and "User devices supporting secure payment").

coexistence, it is important to ensure “interoperability” between CBDC and other types of payment instruments. It is expected that this will improve the convenience of each type of payment instrument, expand the range of user choice, promote competition in the field of payment services, and strengthen the resilience of the payment and settlement systems as a whole.

The following section outlines the relationship and interoperability between CBDC and other types of payment instruments.

Figure 15: “Vertical coexistence” and “horizontal coexistence”

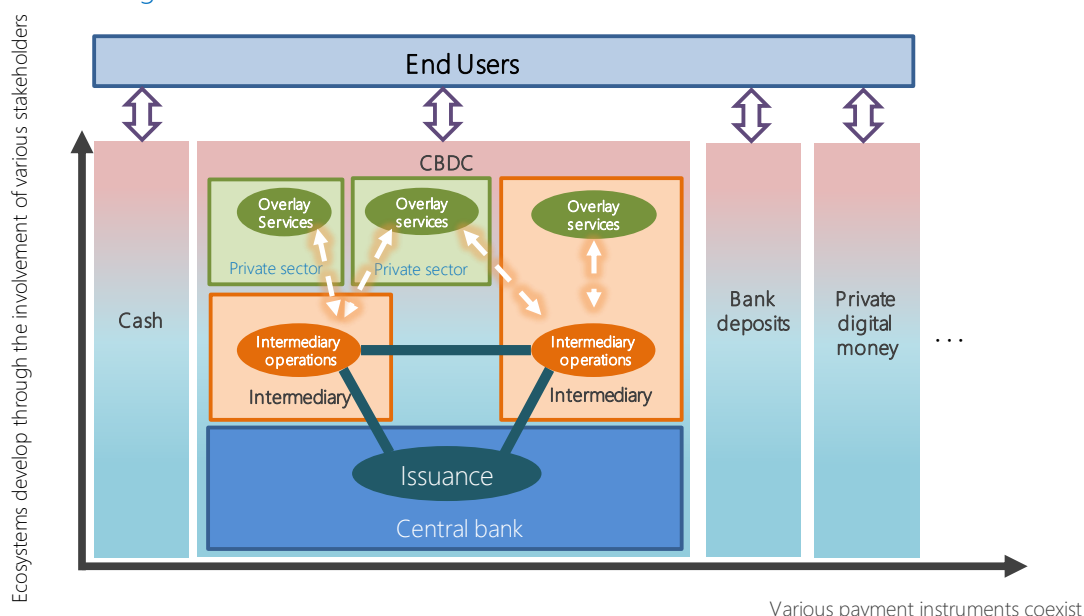
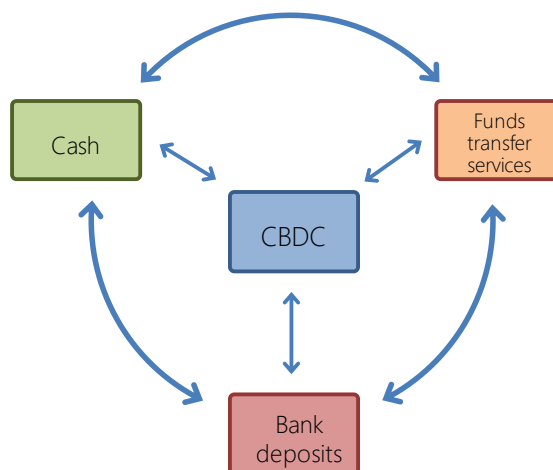

Figure 16: Horizontal interoperability



3.2.1 Relationship with cash

CBDC and cash (banknotes), both as the central bank money, complement each other. Based on this understanding, the BOJ will stay committed to supplying cash as long as there is demand

from the public for it, even if it issues CBDC in the future, as indicated in the Approach. In Japan, where confidence in cash has always been strong, it is unlikely that the cash in circulation would drop significantly for the time being. Rather, it is expected that CBDC and cash will coexist for a considerable period of time, during which the optimal balance between CBDC and cash will be sought by individuals, firms, and financial institutions.

Institutional arrangements regarding CBDC should proceed on the basis of the situation described above. For example, ensuring interoperability between cash and CBDC is relevant. An opinion was raised at the Liaison Committee that, assuming that the two will continue to coexist for some time, it may not be necessary for CBDC to inherit, from its initial rollout, all the features for cash at present such as use in offline environments.

3.2.2 Relationship with bank deposits

Bank deposits currently play a wide variety of roles in terms of user attributes and size of amounts, including large value business-to-business payments, in addition to play a role as a store of value for the public. Furthermore, while banks, through providing their bank deposits, perform the credit creation functions essential for economic activities, CBDC, like cash, does not have such a function. Thus, bank deposits and CBDC play different roles, and one cannot completely replace the other.

In this context, potential attention should be paid to the substantive impact of the issuance of CBDC on bank deposits. Namely, depending on the CBDC product design, the "interoperability" between them may lead to a rapid or continuous shift in funds from bank deposits to CBDC. The situation where severe imbalance of money would have adverse effects on the financial system and economic activities must be avoided. In this regard, an opinion was raised at the Liaison Committee that "If the introduction of CBDC leads to the outflow of bank deposits above a certain volume and interrupts banks' credit creation functions, this could take a toll on the local economy. Taking such a negative impact into account, it is necessary to discuss effective measures such as setting caps on CBDC holding and transaction amount."

In a report released in September 2021,¹⁴ the CBDC Coalition, consisting of seven central banks from Japan, the United States, and Europe, touched upon several potential "safeguards" to deal with this situation. The options listed include applying caps to the amount of CBDC held and/or

¹⁴ "Central Bank Digital Currencies: Financial Stability Implications" (Group to evaluate the feasibility of central bank digital currencies, September 2021). For more information on the group's activities, see the Appendix.

transacted as a “quantitative” safeguard and applying a sufficiently low interest rate, including negative one, to CBDC or charging users a fee as a “price” safeguard. As mentioned above, the BOJ will also assess the technical feasibility and issues of setting caps on the amount of CBDC held and/or transacted as well as remunerations on CBDC in the PoC Phase 2, which started in April 2022.

On the other hand, an opinion was raised at the Liaison Committee that the shift in funds from bank deposits due to changes in people's preference for liquidity driven by the issuance of new money is not unique to CBDC and will not necessarily occur. For example, at present, "smooth exchange of cash and deposits" based on the establishment and expansion of ATM networks is one of important factors for individuals and firms when selecting a bank to do business with. In the same way, assuming a situation where CBDC will be widely used as a payment instrument in the future, "smooth exchange of CBDC and deposits" and "attractive services related to CBDC" could become new criteria for individuals and firms to choose their bank. As a result, deposit taking of banks that utilize CBDC may be more stable than by those that do not.

Keeping these various views in mind, the BOJ recognizes it is necessary to carefully analyze how much impact the introduction of CBDC will have on bank deposits and whether such impact is temporary at the time of CBDC introduction or continues as a long-term problem. In addition, in cooperation with stakeholders, the BOJ would like to design a scheme to ensure an appropriate balance between the convenience of CBDC and the stability of the financial system.

3.2.3 Relationship with private digital money

Over the past few years, many PSPs in Japan have issued digital moneys and competed with each other. Under these circumstances, users have raised such problems as different availability of payment services among different shops and no availability of funds transfers between individuals across different digital money services, leading to the inability to fully benefit from economies of scale and network externalities. In contrast, if CBDC is issued in the future, private money will be able to be easily exchanged with each other or to be obtained against other types of payment instruments via the public platform (i.e., CBDC), if the issuers of such private money so want. Thus, the successful coordination of CBDC with private digital money could greatly increase its convenience and improve the efficiency of the entire payment and settlement systems.¹⁵

¹⁵ When a PSP issues private money backed by deposits with the central bank, the mechanism is sometimes referred to

In addition to such "horizontal coexistence" between private digital money and CBDC, private businesses could develop new businesses within the CBDC eco-system as outsourced entities for intermediary operations or overlay service providers, as described in Section 3.1.

3.3 Ensuring privacy and proper handling of user information

In considering the issuance of CBDC, it is necessary to prescribe the division of roles between the central bank and the private sector, i.e., who will acquire and control the data, to what extent, and under what conditions, while taking into account various requirements regarding the handling of user information. A member of the Liaison Committee also pointed out that, unlike cash, it is easy to obtain personal information and transaction history about CBDC, which might explore considerable potential for utilization of such data and at the same time control of information needs to be carefully considered.

How such user information should be protected and utilized needs to be examined respectively for (1) the infrastructure part for providing a "foundational payment instrument" and (2) the "overlay services" part that addresses individual user needs, as summarized in Section 3.1.

First, in the infrastructure part, in order for CBDC to be widely adopted by users as a foundational payment instrument, it is necessary to achieve robust privacy protection for the user information obtained and utilized by intermediaries and/or the BOJ, including the transaction information (ID/account number, transaction date and time, and amount) that is required for each payment.¹⁶

In relation to existing laws and regulations, information relating personal users is subject to protection under the Act on the Protection of Personal Information and other relevant laws and regulations. In addition, confidentiality obligations imposed on financial institutions would apply to user information which is not public. On the other hand, in the digital society, AML/CFT would become more important than ever, so CBDC must establish a framework to ensure appropriate compliance with it. In this sense, the same anonymity as cash is not always granted. It will be necessary to continue to consider the role of the BOJ and intermediaries regarding this area, as

as "synthetic CBDC" (the money in question is not a liability of the central bank and therefore not a CBDC).

¹⁶ The G7 report (October 2021) identified "Data privacy" as the topic of one of the public policy principles for retail CBDCs, stating: "Users of any CBDC should have a high degree of transparency regarding the use of their personal data, centred around the principles of data minimisation and control for the user (wherever possible). Access to individual users' data beyond the minimum required should be supported by a strong consent framework....."

well as the need for consequent legislative action.

Regarding "overlay services," information is transferred only between the private service providers and the users. The central bank is not in a position to obtain or utilize the user's transaction information. For the private service providers, the information provided by users can be a source of new services and businesses. From the perspective of user convenience and adding value of overlay services, how the private sector can effectively utilize user information will be an issue to be considered due course.

Such utilization of user information is obviously allowed subject to general laws, regulations and other rules for the protection of personal information. Private businesses are required to handle information appropriately, for example obtaining respective consent from users for the acquisition, utilization, and provision to third parties of information associated with the provision of overlay services.

3.4 Relationship with cross-border payments

In recent years, there has been an increasing demand for more convenient and inexpensive cross-border payment services, partly due to the influence of globalization and the worldwide stablecoin initiatives. Against this backdrop, international discussions are underway to improve the framework of international funds transfer, where the exchange of CBDCs among several countries is one of the options being considered for the future.

The priority for central banks in exploring CBDC is to improve the stability and efficiency of their own payment and settlement systems. On this basis, the BOJ recognizes that it is appropriate by taking this opportunity, at a time when many countries are accelerating their discussions on CBDC, to give a thorough consideration to the utilization of CBDC in cross-border payments as an extension of the considerations given in domestic context.

Figure 17: International discussions on cross-border payments

October 2020	Seven central banks and the BIS published "Central Bank Digital Currencies: Foundational Principles and Core Features," noting that "An interoperable CBDC...could play a role in improving cross-border payments."
October 2020	The FSB has published " Enhancing Cross-border Payments: Stage 3 roadmap " positioning CBDC as one of the new payment systems that could address the challenges faced by the existing remittance system.
July 2021	CPMI and others published joint report "Central bank digital currencies for cross-border payments" which analyzes the efforts in each country in line with the above "Roadmap".
October 2021	<p>G7 Finance Ministers and Central Bank Governors Meeting released "Public Policy Principles for Retail Central Bank Digital Currencies," outlining the role of CBDC for cross-border functions.</p> <div style="border: 1px solid black; padding: 5px;"> <p>Principle 12: Cross-border functionality</p> <p>Jurisdictions considering issuing CBDCs should explore how they might enhance cross-border payments, including through central banks and other organisations working openly and collaboratively to consider the international dimensions of CBDC design.</p> </div>
to July 2022	CPMI and others analyze options for access and interlinking to CBDC of each jurisdiction to improve cross-border payments in line with the above "Roadmap".

If CBDCs are envisioned for cross-border payment usage, it is important to broaden consideration about how to ensure "interoperability" and "reliability" through standardization of information technology so that different CBDCs can be exchanged smoothly and securely. The "areas of standardization" that contribute to these objectives include (1) data transmission formats and data elements (e.g., ISO20022), (2) numbering and coding systems for identifying necessary data (identifiers), and (3) technologies for secure data transmission.¹⁷

Figure 18: Areas where standardization is expected

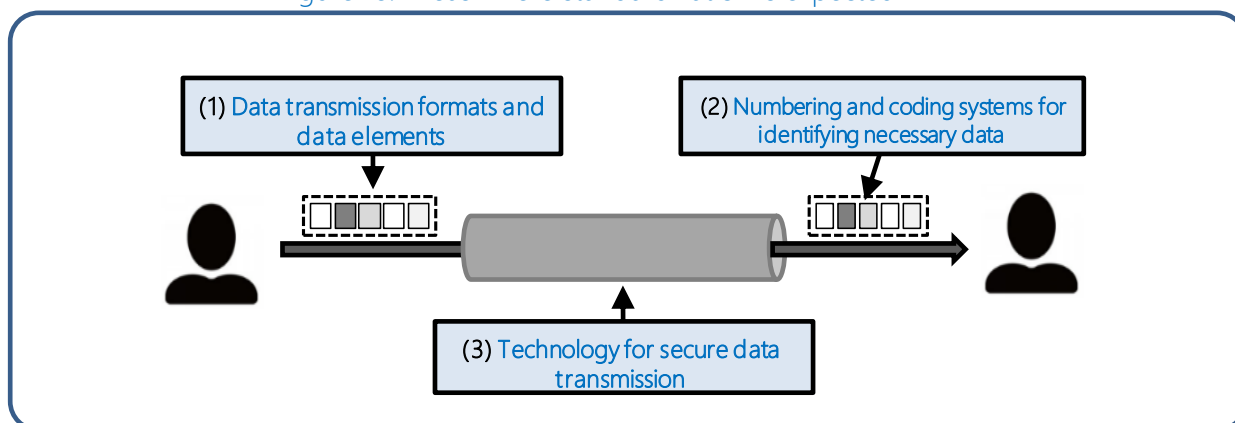

¹⁷ Payment and Settlement Systems Report Annex Series, "Standardization in Information Technology related to Digital Currencies" (BOJ, Payment and Settlement Systems Department, June 2021) and "Interoperability and Standardization in Financial Services in the Digital Age" (ibid., April 2022).

The CBDC Coalition of seven central banks is continuing active discussions on international standards applicable to CBDC as one of the main issues to be considered. The BOJ will continue to be intently involved in the activities of ISO/TC 68¹⁸ and contribute actively to international discussions on standardization.

3.5 Next Steps

Based on the discussions at the Liaison Committee, the following points should be considered going forward, in addition to the issues described in Sections 3.1 to 3.4.

The first is the CBDC system's own business model, i.e., the cost sharing for making the CBDC system sustainable as a whole. As mentioned above, the CBDC system can be divided into two areas: the infrastructure part to provide "foundational payment instrument" and the "overlay services" part that addresses individual user needs. For the latter, where PSPs are expected to compete with each other, the quantity and price of overlay services will be determined based on the supply and demand principles. Rather, the question is who should cover the cost of providing the foundational payment instrument (the infrastructure part), and in what manner.

In regard to this point, an opinion was raised at the Liaison Committee that "Cost design should be considered based on the characteristics of CBDC as a public good in order to ensure its smooth and stable circulation," and that "Cost efficiency should be pursued not only for the BOJ's system but also for society as a whole including intermediaries." The view that "Even after the introduction of CBDC, since the need to use cash is expected to remain strong, especially in rural areas, the administrative cost of cash and the adaptation cost related to CBDC may be incurred in parallel," was also presented in the Liaison Committee.

Approaches to covering the operating costs of the infrastructure part should be considered according to the specifics of institutional arrangements and product design, but in light of recent discussions abroad, various options (or a combination of these options) are possible, including (1) beneficiaries' burden (e.g., overlay service providers, shops, general users who benefit from the introduction of CBDCs), (2) coverage through benefits and cost savings received by intermediaries, and (3) public funding. In relation to this point, an opinion was raised at the Liaison Committee that "Attention should also be paid to ensuring economic rationalization of intermediaries and

¹⁸ A technical committee responsible for international standardization in the field of financial services in ISO. The BOJ's Payment and Settlement Systems Department serves as the national secretariat.

maintenance of level playing field for diverse private businesses.", and that "Since CBDC plays a role as a public infrastructure, it might be reasonable to give further consideration to this issue putting an emphasis on the public funding."

The second issue for consideration is the CBDC's relationship with legal systems in various areas and the foundational contractual arrangements among relevant parties.

Ensuring the effectiveness and stability of CBDC from a legal perspective is essential for building a secure and efficient payment and settlement systems. A member of the Liaison Committee also expressed the view that it is necessary to consider many issues regarding currency laws, including highlighting the necessity to grant the legal tender status to CBDC.

Third, specific measures to enhance cooperation among stakeholders and external communication are also important issues to consider.

The scope of stakeholders will further expand as discussions regarding the issuance of CBDC progress and materialize. For this reason, consideration should be given to expanding the membership of the Liaison Committee, which currently consists mainly of financial industry representatives. In addition, an opinion was raised at the Liaison Committee that "if cost design based on public funding is to be brought into awareness, proper methods to incorporate the voices of end users such as consumers and small and medium-sized firms will be necessary in the future." In addition, efforts should be made to provide more easily comprehensible information to the public who will be the future users. One way to do this would be to give the CBDC project a specific name, following the example of other countries.

Concluding thoughts and next steps

As expressed in Introduction, while the BOJ “currently has no plan to issue CBDC, the BOJ considers it important to prepare thoroughly to respond to changes in circumstances in an appropriate manner”. What is important is to envision “the future of payment and settlement systems suitable for a digital society”, and in this sense, CBDC is only one means of achieving this goal. CBDC, as a public good, must complement and coexist with private payment services, and as a result of consideration, it might be concluded that approaches other than CBDC should be sought in order to achieve secure and efficient payment and settlement systems.

In fact, there are some cautiousness about the introduction of CBDC due to the strong preference for cash and high ratio of bank account holding in Japan. However, this situation is similar in other developed countries, and at this point, there are few countries that have a clear use case for CBDC. Nevertheless, the fact that CBDC is being seriously considered as a realistic future option in many countries must be taken seriously. Any of these countries is discussing, focusing on use cases and payment and settlement systems expected in the future, instead of those recognized in the present situation.

With the steady progress of digitization in all areas of society, sooner or later the time will come in Japan when how to deal with the social costs associated with cash circulation will have to be seriously considered. In addition, in the world of digital money, it is highly likely that new types of money, such as stablecoin and decentralized finance, will continue to emerge. In this context, one future direction is for the BOJ to provide broadly secure and neutral payment instruments called CBDC in order to avoid fragmentation and monopolization of payment services, and to enable private businesses to utilize these as a source for creating new services.

In addition, as payment services become more sophisticated, it will become increasingly difficult for existing payment and settlement systems alone to meet the diverse needs of end users, in terms of speed and cost. A new and highly flexible CBDC system may be able to respond quickly to future user needs. One idea is that through such a process, by carving out the infrastructure part (non-competitive area) and providing CBDC as a public good, the investment cost incurred by the private sector could be lowered. In any case, it is important to discuss the significance and role of CBDC from the perspective of “whether the problems we will face in the future can be solved without CBDC or whether CBDC would lead to better solutions,” rather than discussing the need for CBDC

based on the current situation.

Whether CBDC is introduced or not will ultimately depend upon the public decision. Opinions such as, “Even if CBDC is introduced, it will not be fully utilized unless the public understanding is gained, including its necessity, as a basic infrastructure suitable for a digital society,” and “It is necessary to build a consensus that the introduction of CBDC will bring positive added value to society as a whole, in parallel with institutional arrangements.” were raised at the Liaison Committee. The BOJ will continue to make necessary preparations and external communication, while keeping these points in mind. Through these efforts, we expect the circle of discussion on the future of Japan’s payment and settlement systems will be expanded.

Appendix: Status of works abroad

(1) Expansion of works in the world

In a survey conducted by the Bank for International Settlements (BIS) (October-December 2020), 86% of the 65 responding central banks have already been engaged in some kind of CBDC work. According to the survey, an increasing number of central banks have been considering general-purpose CBDC over wholesale CBDC in the past few years. Regarding their works, an increasing number of central banks are embarking on more concrete and practical initiatives such as “experiments or proof-of-concept” and “development or pilot arrangement,” in addition to conceptual research activities.¹⁹

Figure 19: CBDC works by central banks

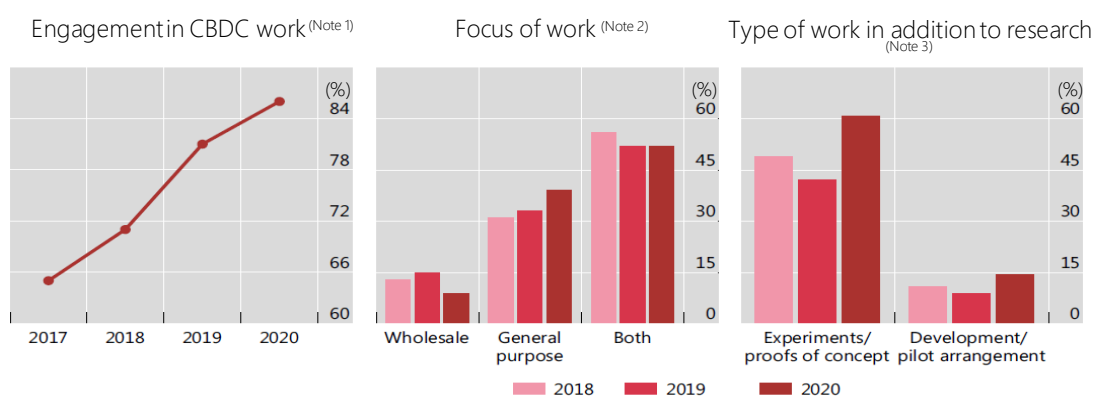

(Note 1) Share of respondents conducting work on CBDC in the 65 central banks that participated in the survey.

(Note 2) Share of respondents considering wholesale/general-purpose CBDC in the central banks who responded that they are considering CBDC.

(Note 3) Types of studies conducted in addition to the usual survey by respondents engaged in wholesale/general-purpose CBDC studies.

(Source) Boar, Codruta and Andreas Wehrli, “Ready, Steady, Go? – Results of the Third BIS Survey on Central Bank Digital Currency,” BIS, January 2021.

(2) International “principles” for general purpose CBDCs

The growing consideration of CBDC in the world is due not only to the decline in the use of cash as a result of the development of cashless payments but also greatly to the emergence of the Libra initiative in 2019, intended as a global stablecoin. In response to these developments, a “Central bank group to assess potential cases for central bank digital currencies” was formed in January 2020, consisting of seven central banks (Japan, the United States, the Euro Area, the United Kingdom,

¹⁹ According to the latest BIS survey published in May 2022 (October-December 2021), the number of central banks conducting CBDC research has increased to 90% out of the 81 responding central banks. Also, more than half of the central banks have conducted proof-of-concept or pilot arrangements for general-purpose CBDC and “about 68% of central banks consider that they are likely to or might possibly issue a retail CBDC in the short or medium term.”

Canada, Switzerland, and Sweden) and the BIS (called herein the CBDC Coalition). Since then, the CBDC Coalition has been a driving force in international discussions on CBDC, and in October of the same year, the group compiled and published three “foundational principles” required for general purpose CBDC.²⁰

The first foundational principle is “Do no harm” to monetary and financial stability: the issuance of a CBDC should not interfere with or impede a central bank’s ability to carry out its mandate for monetary and financial stability.

The second foundational principle is “Ensure coexistence and complementarity of public and private forms of money”: Different types of central bank money, i.e. CBDC and banknote, should complement one another. It is also important that private money, including commercial bank deposits, and CBDC, coexist and contribute to the financial system and real economy in an appropriate balance.

The third foundational principle is “Promote innovation and efficiency”: public authorities and private sectors have their own roles to play in ensuring secure and efficient payment and settlement systems. In considering the issuance of CBDC it is also necessary to incorporate continuous innovation and competition from private sectors in order to promote its efficiency.

Figure 20: “Foundational principles” of the CBDC Coalition

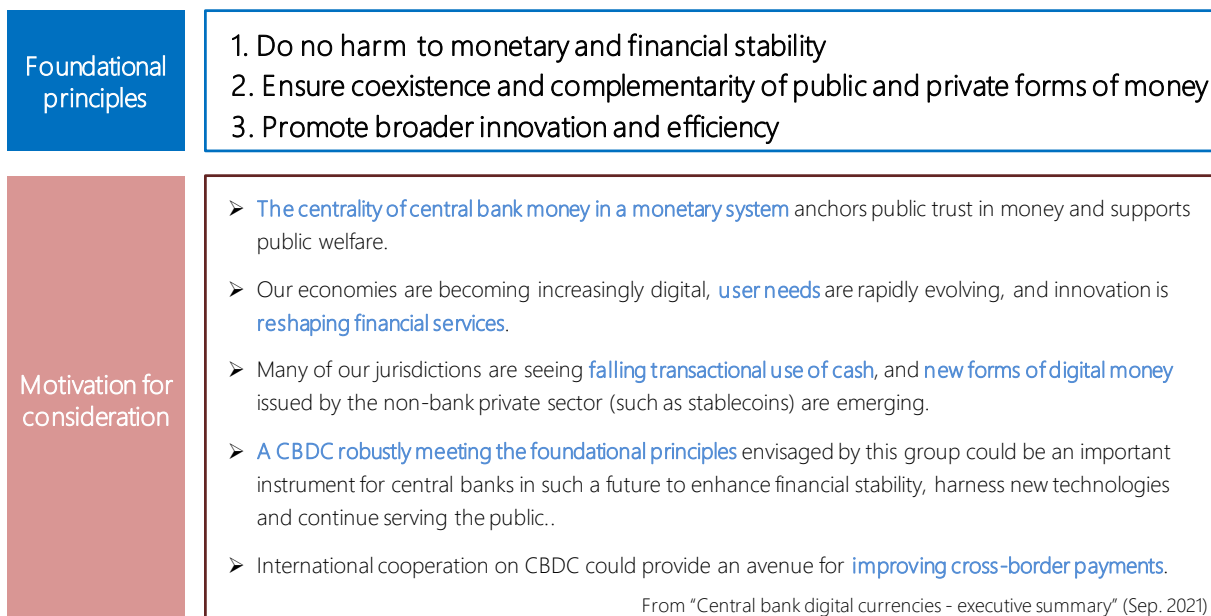

²⁰ “Central Bank Digital Currencies: Foundational Principles and Core Features” (October 2020)

The CBDC Coalition continued to conduct in-depth policy analysis and practical studies in line with the three foundational principles, and in September 2021, published three reports summarizing the discussions

Figure 21: Report of the CBDC Coalition (September 2021)

(1) System design and interoperability

- The central banks contributing to this report anticipate any CBDC ecosystems would involve the public and private sectors in a balance...
- For CBDC systems, domestic interoperability would need to be sufficient to achieve an easy flow of funds to and from other payment and settlement systems.
- Access to and treatment of payment data would play a significant role in any ecosystem design.

(2) User needs and adoption

- A CBDC would need to anticipate the needs of future users and incorporate related innovations..
- Central banks might accommodate evolving user needs by designing a flexible core system, supporting a diverse ecosystem of intermediaries delivering option, competition and innovation..
- Strategies for CBDC adoption would need to be tailored to the diverse economic structures and payment landscapes in individual jurisdictions.

(3) Financial stability implication

- A significant shift from bank deposits into CBDCs (or even into certain new forms of privately issued digital money) could have implications for lending and intermediation by the banking sector.
- Central banks are exploring safeguards that could be built into any CBDC to address financial stability risks. The design of any measures would likely need to balance moderating the risks from high and/or rapid take up of CBDC with other policy objectives...

In addition, the G7 Finance Ministers and Central Bank Governors have also been discussing CBDC, and in October 2021, the G7 released “Public Policy Principles for Retail Central Bank Digital Currencies (CBDCs)” consisting of 13 principles, including “monetary and financial stability” and “data privacy.” The BOJ recognizes that these principles, which reflect sense of values shared by the G7 countries, will provide an important perspective for the BOJ in order to move forward CBDC experiments and investigations into institutional arrangements.

(3) Status of studies on general purpose CBDC in other jurisdictions

Figure 22: List of Public Policy Principles for Retail CBDCs

Foundational Issues	Opportunities
1 . Monetary and financial stability	9 . Digital economy and innovation
2 . Legal and governance frameworks	10. Financial inclusion
3 . Data privacy	11. Payments to and from the public sector
4 . Operational Resilience and Cyber Security	12. Cross-border functionality
5 . Competition	13. International development
6 . Illicit finance	
7 . Spillovers	
8 . Energy and Environment	

① China

Among major countries, China is the most advanced in its studies on general-purpose CBDC. In China, research on digital renminbi (e-CNY) started in 2014, and pilot R&D projects involving a large number of citizens and shops have been continuing since the end of 2019 onward, with an expansion of the areas covered taking place. Through the pilot projects, 260 million individual wallets (as of the end of 2021) and 10 million corporate wallets (as of the end of October 2021) have been opened. The People's Bank of China (PBOC), while stating that there is "no preset timetable for the final launch," has indicated that it intends to (a) forge ahead with the pilot R&D projects, (b) improve relevant institutional arrangements and rules, and (c) deepen analysis of the impact on financial and other related systems, and participate in international exchanges of views.

② The Euro Area

In July 2021, the ECB announced the launch of the "investigation phase" of a digital euro project, lasting till October 2023. President Lagarde also stated that "It is at the end of that investigation phase that the decision will definitely be made to launch the CBDCs and to make it a reality." Regarding the July 2021 decision, the ECB stated that it "will not prejudge any future decision on the possible issuance of a digital euro," but nevertheless, it is considered an important development that the Euro Area, following China, has clearly shown a positive attitude toward the introduction of CBDCs.

③ The United States

In January 2022, the FRB released a discussion paper outlining the benefits, risks, and policy considerations of CBDCs and soliciting the public comments, including on matters related to "CBDC design." Separately from this paper, the Boston Fed is continuing its collaboration with MIT on infrastructure technology (called "Project Hamilton") beyond 2020, and in February 2022 published a whitepaper on the findings of Phase 1 (experiments in performance on a small-scale CBDC system). In addition, the Executive Order on Ensuring Responsible Development of Digital Assets, issued in March, placed the highest urgency on research and development of CBDC for the administration, and directed other federal government authorities in addition to the FRB to pursue CBDC research.

④ Other jurisdictions

Among developed countries, Sweden is ahead of other jurisdictions in the study; since 2020, experiments on general purpose CBDC (e-krona) have been conducted in phased approach, shifting to the third phase in February 2022. By the end of November 2022, the report of the committee formed at the request of Parliament on the necessity to issue e-krona will be submitted to the government.

Looking at emerging countries, several jurisdictions have already taken steps to issue general purpose CBDCs, and more recently, countries with large populations, such as Nigeria and India, are developing specific initiatives to do so.

Figure 23: Status of works in each country

United Kingdom	In November 2021, the Bank of England (BOE) announced the implementation of public consultation (in collaboration with the HM Treasury) on the general purpose CBDC in 2022. In March 2022, the BOE announced the implementation of a 12-month joint research with MIT in the United States.
Canada	In February 2020, the Bank of Canada (BOC) released a report on general purpose CBDCs. In March 2022, the BOC announced the implementation of a 12-month joint research with MIT in the United States.
Sweden	In February 2020, the Swedish Riksbank began pilot tests on general use CBDC (e-krona). By the end of November 2022, the report of the study committee formed at the request of Parliament on the necessity to issue e-krona will be submitted to the government.
Switzerland	In December 2019, the government released a report on CBDC, stating that "Universally accessible central bank digital currency would bring no additional benefits for Switzerland at present."
Cambodia	In October 2020, the National Bank of Cambodia announced the official launch of BAKONG The Next-Generation Mobile Payments .
The Bahamas	In October 2020, the Central Bank of The Bahamas announced the official nationwide issuance of general purpose CBDC (Sand Dollar).
Eastern Caribbean Currency Union (8 jurisdictions)	In March 2021, the Eastern Caribbean Central Bank announced the official launch of the general purpose CBDC (DCash) in four jurisdictions in the region. The remaining four jurisdictions are in the process of rolling out the system.
Nigeria	In October 2021, the Central Bank of Nigeria announced the official issuance of a general purpose CBDC (eNaira).
Jamaica	In December 2021, the Bank of Jamaica announced the official issuance of a general purpose CBDC for the first quarter of 2022.
India	In February 2022, the government proposed to issue a general-purpose CBDC (Digital Rupee) during FY2022.

(Attachment)

“Liaison and Coordination Committee on Central Bank Digital Currency” Members and others

As of April 13, 2022

Members	Japanese Bankers Association Regional Banks Association of Japan Second Association of Regional Banks International Bankers Association of Japan National Association of Shinkin Banks National Central Society of Credit Cooperatives National Association of Labour Banks Japan Securities Dealers Association Japan Payment Service Association Japan Association for Financial APIs Fintech Association of Japan Center for Financial Industry Information Systems Financial Services Agency Ministry of Finance Bank of Japan
Secretariat	Bank of Japan Payment and Settlement Systems Department

Past Meetings

First session: March 26, 2021

Second session: October 15, 2021

Third session: April 13, 2022